

**ROCKFALL CATCHMENT AREA
DESIGN GUIDE**

**FINAL REPORT
SPR-3(032)**

by

Lawrence A. Pierson, C.E.G., Senior Engineering Geologist
Landslide Technology

and

C. Fred Gullixson, C.E.G., Senior Engineering Geologist
Oregon Department of Transportation

and

Ronald G. Chassie, P.E.
Geotechnical Engineer

for

Oregon Department of Transportation – Research Group
200 Hawthorne Avenue SE – Suite B-240
Salem, OR 97301-5192

and

Federal Highway Administration
400 Seventh Street SW
Washington, DC 20590

November 2001

1. Report No. FHWA-OR-RD-02-04		2. Government Accession No.		3. Recipient's Catalog No.	
4. Title and Subtitle ROCKFALL CATCHMENT AREA DESIGN GUIDE Final Report				5. Report Date November 2001	
				6. Performing Organization Code	
7. Author(s) Lawrence A. Pierson, C.E.G., Landslide Technology, Portland, OR, USA C. Fred Gullixson, C.E.G., Geo/Hydro Section, Oregon Dept. of Transportation Ronald G. Chassie, P.E. Geotechnical Engineer, FHWA (Retired)				8. Performing Organization Report No. SPR-3(032)	
9. Performing Organization Name and Address Oregon Department of Transportation Research Group 200 Hawthorne Ave. SE Salem, OR 97301-5192				10. Work Unit No. (TRAIS)	
				11. Contract or Grant No.	
12. Sponsoring Agency Name and Address Research Group and Federal Highway Administration Oregon Department of Transportation 400 Seventh Street, SW 200 Hawthorne Ave. SE Washington, DC 20590 Suite B-240 Salem, OR 97301-5192				13. Type of Report and Period Covered Final Report	
				14. Sponsoring Agency Code	
15. Supplementary Notes					
16. Abstract The data gathered from an extensive research project consisting of rolling approximately 11,250 rocks off vertical; 0.25H:1V; 0.5H:1V; 0.75H:1V; and 1.0H:1.0V slopes of three different heights (40, 60 and 80 feet) into three differently inclined catchment areas (flat, 6H:1V and 4H:1V) has been used to develop design charts for dimensioning rockfall catchment areas adjacent to highways. A standard suite of 250 rocks was rolled for each slope and catchment area configuration tested. The standard suite included 100 rocks averaging 1 foot in diameter, 75 rocks averaging 2 feet in diameter and 75 rocks averaging 3 feet in diameter. The data was evaluated using statistical and graphical methods. The design charts are presented in a "practitioner-friendly" form that can be used to rapidly dimension rockfall catchment areas that satisfy specific rock catching/retention requirements. Based on cut slope angle and height and catchment area slope, the design charts estimate the catchment area widths required to retain percentages of rockfall ranging up to 99 percent. Design guidelines and step-by-step design procedures are presented and illustrated with three worked example design problems. Seven actual highway project case study examples are also presented. They illustrate the practical application of the design procedure and design charts and/or use of site-specific rock rolling to aid in the rockfall mitigation design. This report documents the test methods, the fieldwork performed, the data gathered, the means of analysis, the research results and sample application of the design charts. The data results in both tabular and graphical form are included in the Appendices. The Appendices also include the detailed project case study application examples.					
17. Key Words Rockfall, rockfall catchment area, rockfall catchment area design charts, rockfall ditch, rockfall fallout area, rockfall catch ditch, rockfall research, rockfall energy data, Ritchie ditch.			18. Distribution Statement Available through NTIS, and online at http://www.odot.state.or.us/tddresearch		
19. Security Classification (of this report) Unclassified		20. Security Classification (of this page) Unclassified		21. No. of Pages 91 + appendices	22. Price

SI* (MODERN METRIC) CONVERSION FACTORS

APPROXIMATE CONVERSIONS TO SI UNITS

Symbol	When You Know	Multiply By	To Find	Symbol
<u>LENGTH</u>				
in	inches	25.4	millimeters	mm
ft	feet	0.305	meters	m
yd	yards	0.914	meters	m
<u>AREA</u>				
ft ²	square feet	0.093	meters squared	m ²
ac	acres	0.405	hectares	ha
mi ²	square miles	2.59	kilometers squared	km ²
<u>VOLUME</u>				
ft ³	cubic feet	0.028	meters cubed	m ³
yd ³	cubic yards	0.765	meters cubed	m ³
NOTE: Volumes greater than 1000 L shall be shown in m ³ .				
<u>MASS</u>				
oz	ounces	28.35	grams	g
lb	pounds	0.454	kilograms	kg
T	short tons (2000 lb)	0.907	megagrams	Mg
<u>ENERGY</u>				
ft-lb	foot-pounds	1.35582	joules	J
ft-T	foot-tons	2.71164	kilojoules	kJ
<u>TEMPERATURE (exact)</u>				
°F	Fahrenheit temperature	5(F-32)/9	Celsius temperature	°C

APPROXIMATE CONVERSIONS FROM SI UNITS

Symbol	When You Know	Multiply By	To Find	Symbol
<u>LENGTH</u>				
mm	millimeters	0.039	inches	in
m	meters	3.28	feet	ft
m	meters	1.09	yards	yd
<u>AREA</u>				
m ²	meters squared	10.764	square feet	ft ²
ha	hectares	2.47	acres	ac
km ²	kilometers squared	0.386	square miles	mi ²
<u>VOLUME</u>				
m ³	meters cubed	35.315	cubic feet	ft ³
m ³	meters cubed	1.308	cubic yards	yd ³
<u>MASS</u>				
g	grams	0.035	ounces	oz
kg	kilograms	2.205	pounds	lb
Mg	megagrams	1.102	short tons (2000 lb)	T
<u>ENERGY</u>				
J	joules	0.73756	foot-pounds	ft-lb
kJ	kilojoules	0.36878	foot-tons	ft-T
<u>TEMPERATURE (exact)</u>				
°C	Celsius temperature	1.8C + 32	Fahrenheit	°F

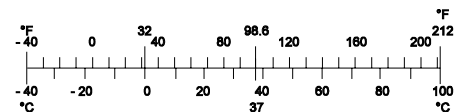

* SI is the symbol for the International System of Measurement

ACKNOWLEDGMENTS

Funding for this research project was provided through a regional pooled fund project administered by the Oregon Department of Transportation (ODOT). Funding contributors were the Alaska, Arizona, California, New York, Oregon, Tennessee, Washington, and Wyoming State Departments of Transportation along with the Federal Highway Administration (FHWA) Western and Central Federal Lands Highway Divisions (Vancouver, WA and Denver, CO), FHWA Washington, DC Office of Technology Applications and FHWA former Region 10 Portland, OR office. Jointly, these agencies contributed over \$650,000 to accomplish this needed work. Their funding contributions are gratefully acknowledged.

Execution of the study and preparation of the final report was a collaborative effort. Larry A. Pierson, Senior Engineering Geologist, Landslide Technology, provided overall project management. C. Fred Gullixson, Senior Engineering Geologist, ODOT Region 1, was in charge of recording field data and preparing the data summaries and design charts. Ronald G. Chassie, FHWA Senior Geotechnical Engineer (Retired) provided technical consulting, report preparation, review and final editing.

A hard working ODOT crew consisting of the following personnel carried out the project fieldwork: Jim Kendall, James Kirby, Bob Colby, Mike Fisher, and T. Anderson. John Marks, ODOT Geotechnical Services assisted with project and contract management. John Kazmierski, ODOT video services, shot video footage at selected times. Many thanks to all these good people for their dedicated and professional work.

Special appreciation is extended to Liz Hunt, Research and T2 Coordinator, Oregon DOT; Alan Kirk, Research Analyst, Oregon DOT; Bob Raths, Research, T2 & Quality Improvement Program Manager, FHWA Oregon Division; and Cal Frobig, Technology Transfer Engineer, FHWA-WFLHD, Vancouver, WA for their funding, technical and administrative support throughout the duration of this project.

A Technical Advisory Committee (TAC) of highly experienced engineering geologists and geotechnical engineers was formed from the contributing agencies to guide the project and to critically review the work and this document. TAC members were:

Dave Stanley	Chief Geologist	Alaska DOT
John Lawson	Chief Geotechnical Engineer	Arizona DOT
John Duffy	Senior Engineering Geologist	California DOT
Mike Vierling	Engineering Geologist II	New York State Thruway Authority
Don Turner	Geotechnical Services Unit	Oregon DOT
Bill Trolinger	Chief Geotechnical Engineer	Tennessee DOT
Steve Lowell	Chief Engineering Geologist	Washington DOT
Mark Falk	Geological Engineer	Wyoming DOT
Barry Siel	Senior Geotechnical Engineer	FHWA-CFLHD, Denver, CO
Alex Yatsevitch	Engineering Geologist 3	New York DOT

The TAC provided the overall quality assurance needed to assure a high-quality effort and the development of a practitioner-friendly and practitioner-oriented Design Guide. Their contributions are gratefully acknowledged and sincerely appreciated.

DEDICATION TO ARTHUR M. RITCHIE

This report is dedicated to the memory of Arthur M. Ritchie (deceased August 1988). Mr. Ritchie spent a long and productive career as the Chief Geologist with the Washington State Department of Highways. In 1963, the Transportation Research Board (TRB) published a technical paper authored by Mr. Ritchie titled “An Evaluation of Rockfall and Its Control.” Ritchie’s paper summarized the results of a rockfall research project conducted by Washington State.

Ritchie’s innovative and pioneering work was the first practical and comprehensive study of rockfall generated from actual highway slopes. The work included rolling hundreds of rocks off highway and state-owned quarry and talus slopes across Washington State and measuring and recording (including 16mm motion pictures) the paths and distances the rocks traveled. The work culminated in Mr. Ritchie developing a practical design criteria, in table form, that could be used to size the width of flat-bottomed rockfall catchment areas based on rock slope height, rock slope angle and depth of catchment area.

Mr. Ritchie’s work was the first definitive work and practical design guidance presented to highway designers to better and more rationally design safer highways against rockfall. Throughout his career, Mr. Ritchie’s contributions to highway engineering and the geotechnical profession were many and exemplary. The implementation of his research results has surely saved the lives of many people nationwide. The work covered by this report builds on Mr. Ritchie’s original pioneering work.

DISCLAIMER

This document is disseminated under the sponsorship of the Oregon Department of Transportation and the United States Department of Transportation in the interest of information exchange. The State of Oregon and the United States Government assume no liability of its contents or use thereof.

The contents of this report reflect the views of the author(s) who are solely responsible for the facts and accuracy of the data presented herein. The contents do not necessarily reflect the official policies of the Oregon Department of Transportation or the United States Department of Transportation.

The State of Oregon and the United States Government do not endorse products of manufacturers. Trademarks or manufacturers’ names appear herein only because they are considered essential to the object of this document.

This report does not constitute a standard, specification, or regulation.

ROCKFALL CATCHMENT AREA DESIGN GUIDE

TABLE OF CONTENTS

ACKNOWLEDGMENTS	iii
DEDICATION	iv
GLOSSARY OF TERMS	ix
EXECUTIVE SUMMARY	xi
1.0 INTRODUCTION	1
1.1 SIGNIFICANCE OF THE ROCKFALL PROBLEM	1
1.2 ROCKFALL CATCHMENT AREA DESIGN PRACTICE	2
1.3 RESEARCH PROJECT GOALS	2
1.4 REPORT CONTENT SUMMARY	3
1.5 PROJECT BENEFITS	4
1.6 REPORT TERMINOLOGY	4
2.0 BACKGROUND	5
2.1 1963 RITCHIE STUDY.....	5
2.2 LIMITATIONS OF RITCHIE RESEARCH.....	7
2.3 ODOT'S 1994 PILOT STUDY FOR 0.25H:1V SLOPES	8
2.3.1 1994 Survey of Rockfall Catchment Area Design Practice	9
2.3.2 Comparison to a Ritchie Test Catchment Area (Pilot Study).....	10
2.3.3 Comparison with Computer Rockfall Simulation (Pilot Study).....	13
3.0 FULL SCALE TESTING OF ADDITIONAL SLOPES	15
3.1 RESEARCH SITE TEST COMPONENTS.....	15
3.2 SLOPE EFFECTS AND IMPACT DISTANCE	19
3.3 CATCHMENT AREA SLOPE AND ROLL OUT DISTANCE.....	22
3.4 IMPACT DISTANCE VERSUS ROLL OUT DISTANCE	26
3.5 ROCKFALL ENERGY DATA	28
4.0 DESIGN GUIDELINES AND APPLICATION EXAMPLES	31
4.1 DESIGN GUIDELINES	31
4.2 CATCHMENT AREA PERCENT RETENTION GRAPHS.....	32
4.3 CUMULATIVE PERCENT RETAINED DESIGN CHARTS	34
4.4 STEP-BY-STEP DESIGN PROCEDURE	36
4.4.1 Worked Example 1 - Designing a <u>New</u> Catchment Area	36
4.4.2 Worked Example 2 - Evaluating an <u>Existing</u> Catchment Area.....	38
4.4.3 Worked Example 3 - Benefit/Cost Comparison	40
4.4.4 Project Case Study Application Examples.....	42

5.0 COMPLETE SUITE OF DESIGN CHARTS.....	45
5.1 USE OF DESIGN CHARTS.....	45
5.2 DESIGN CHART LIMITATIONS.....	46
6.0 CONCLUSIONS.....	73
6.1 SUMMARY OBSERVATIONS AND CONCLUSIONS.....	73
6.2 FURTHER RESEARCH NEEDS.....	74
7.0 REFERENCES.....	77

APPENDICES

- APPENDIX A: RITCHIE TEST CATCHMENT AREA COMPARISON
- APPENDIX B: ROCK ROLLING FIELD DATA
- APPENDIX C: ROCKFALL IMPACT DISTANCE HISTOGRAMS
- APPENDIX D: ROCKFALL ROLL OUT DISTANCE HISTOGRAMS
- APPENDIX E: ROCKFALL ENERGY DATA
- APPENDIX F: CATCHMENT AREA PERCENT RETENTION GRAPHS
- APPENDIX G: PROJECT CASE STUDY APPLICATION EXAMPLES

LIST OF FIGURES AND PHOTOS

Figure 1.1: Rockfall travel modes (<i>Ritchie 1963</i>).....	1
Figure 2.1: Rockfall travel modes (<i>Ritchie 1963</i>).....	5
Figure 2.2: Ritchie’s rockfall catch ditch design chart (<i>FHWA 1989</i>).....	6
Figure 2.3: Tested slope heights and catchment area configurations (Pilot Study).....	8
Figure 2.4: Tested Ritchie catchment area shape and dimensions.....	11
Figure 2.5: Comparison of tested Ritchie to 4H:1V and 6H:1V sloped catchment areas.....	12
Figure 2.6: Cumulative percentage rockfall retained for tested Ritchie catchment area.....	12
Figure 2.7: Field data and computer simulation comparison (0.25H:1V slope).....	14
Figure 3.1: Tested slope height and catchment area configurations.....	16
Figure 3.2: 80-foot high, 0.25H:1V presplit slope (Oregon test site).....	17
Figure 3.3: Rockfall testing; 40-foot high vertical presplit slope, 2-foot diameter rocks, 4H:1V catchment area foreslope.....	18
Figure 3.4: Rockfall testing; 40-foot high vertical presplit slope.....	18
Figure 3.5: Preferred rockfall paths.....	20
Figure 3.6: 40-foot impact histogram (0.25H:1V slope).....	21
Figure 3.7: 60-foot impact histogram (0.25H:1V slope).....	22
Figure 3.8: 80-foot impact histogram (0.25H:1V slope).....	22
Figure 3.9: Definition of roll out distance.....	23
Figure 3.10: Average roll out distance vs. slope height (0.25H:1V slope).....	24
Figure 3.11: Average roll out distance vs. slope height (1H:1V slope).....	24
Figure 3.12: Roll out histogram, 80-foot slope – flat catchment area.....	25
Figure 3.13: Roll out histogram, 80-foot slope – 6H:1V catchment area.....	25
Figure 3.14: Roll out histogram, 80-foot slope – 4H:1V catchment area.....	26
Figure 3.15: Standard deviation of impact distance (0.25H:1V slope).....	27
Figure 3.16: Standard deviation of roll out distance (0.25H:1V slope).....	28
Figure 3.17: Energy data for 1-foot rocks (80-foot high, 0.5H:1V slope).....	29
Figure 4.1: 50% Retention graph (0.75H:1V slope).....	33
Figure 4.2: 90% Retention graph (0.75H:1V slope).....	34

Figure 4.3: Cumulative percent retained for the 80-foot, 0.25H:1V slope.....	35
Figure 4.4: Design chart for 80-foot high, 0.25H:1V slope (Example 1)	38
Figure 4.5: Design chart for 80-foot high, 0.25H:1V slope (Example 2)	39
Figure 4.6: Slope cross-sections; benefit/cost comparison (Example 3).....	41
Figure 4.7: Example benefit/cost comparison (Example 3)	42
Figure 5.1: Design chart for 40-foot high vertical cutslopes.....	47
Figure 5.2: Design chart for 50-foot high vertical cutslopes.....	48
Figure 5.3: Design chart for 60-foot high vertical cutslopes.....	49
Figure 5.4: Design chart for 70-foot high vertical cutslopes.....	50
Figure 5.5: Design chart for 80-foot high vertical cutslopes.....	51
Figure 5.6: Design chart for 40-foot high 0.25H:1V cutslopes.....	52
Figure 5.7: Design chart for 50-foot high 0.25H:1V cutslopes.....	53
Figure 5.8: Design chart for 60-foot high 0.25H:1V cutslopes.....	54
Figure 5.9: Design chart for 70-foot high 0.25H:1V cutslopes.....	55
Figure 5.10: Design chart for 80-foot high 0.25H:1V cutslopes.....	56
Figure 5.11: Design chart for 40-foot high 0.5H:1V cutslopes.....	57
Figure 5.12: Design chart for 50-foot high 0.5H:1V cutslopes.....	58
Figure 5.13: Design chart for 60-foot high 0.5H:1V cutslopes.....	59
Figure 5.14: Design chart for 70-foot high 0.5H:1V cutslopes.....	60
Figure 5.15: Design chart for 80-foot high 0.5H:1V cutslopes.....	61
Figure 5.16: Design chart for 40-foot high 0.75H:1V cutslopes.....	62
Figure 5.17: Design chart for 50-foot high 0.75H:1V cutslopes.....	63
Figure 5.18: Design chart for 60-foot high 0.75H:1V cutslopes.....	64
Figure 5.19: Design chart for 70-foot high 0.75H:1V cutslopes.....	65
Figure 5.20: Design chart for 80-foot high 0.75H:1V cutslopes.....	66
Figure 5.21: Design chart for 40-foot high 1H:1V cutslopes.....	67
Figure 5.22: Design chart for 50-foot high 1H:1V cutslopes.....	68
Figure 5.23: Design chart for 60-foot high 1H:1V cutslopes.....	69
Figure 5.24: Design chart for 70-foot high 1H:1V cutslopes.....	70
Figure 5.25: Design chart for 80-foot high 1H:1V cutslopes.....	71

TABLES

Table 5.1: Slope ratio/slope angle equivalents	46
--	----

GLOSSARY OF TERMS

The following terms are used in this report. The definitions given apply to the terms as used herein, and other uses and definitions may exist.

AASHTO – American Association of State Highway and Transportation Officials.

Clear Zone – The total roadside border area, starting at the edge of the traveled way that is wide enough to allow an errant driver to stop or regain control of a vehicle. This area might consist of a shoulder, a recoverable slope, and/or a nonrecoverable, traversable slope with a clear run-out area at its toe (Per MUTCD).

Catchment Area – The area between the roadway edge of pavement and the base (toe) of a rock cut slope used to restrict rockfalls from the roadway. The term is synonymous with ditch, rock fallout area, rockfall ditch, rockfall catch ditch, and catch ditch.

Catchment Area Width – The horizontal distance between the roadway edge of pavement and the base (toe) of a rock cut slope.

Controlled Blasting – Special blasting procedures, such as presplitting and cushion blasting, used to minimize blast damage to the final walls of rock slope excavations. Significantly reduces long-term rockfall compared to use of uncontrolled blasting methods.

CRSP – Acronym for the computerized Colorado Rockfall Simulation Program, which is used to model rockfall trajectories and energies based on known slope shapes and estimated properties.

Distribution – A statistical term used to describe the range of experimental data.

Ditch – Synonymous with catchment area.

Fallout Area – Synonymous with catchment area.

Foreslope – The portion of the roadway prism inclined downward from the edge of pavement toward the base of a cut or roadside ditch.

Histogram – A graphic representation of a frequency distribution. In other words, it is a graphical tally of data collected. Frequency histograms have been developed for both impact and roll out distance data points.

Impact Distance – The measured slope distance from the base of the rock cut slope to where a falling rock first strikes the ground.

Launch Feature – Any slope irregularity or deviation in the rock slope face that can be struck by a falling rock and changes the trajectory of the rock.

MUTCD – Manual on Uniform Traffic Control Devices, published by the Federal Highway Administration, U.S. Department of Transportation. Current edition: December 2000 (including Errata No. 1 dated June 14, 2001).

Outlier – A rockfall result (impact or roll out) that exists away from the body of collected experimental data.

Presplitting – A controlled blasting technique utilizing a row of closely spaced, lightly loaded blast holes drilled along the rock slope final excavation line and detonated at least 25 milliseconds before the production blast holes.

Ritchie Ditch – Rockfall catchment area (ditch) configuration and dimensions obtained from an empirical table developed by Washington State Department of Highways Geologist Arthur M. Ritchie in 1963.

Rockfall – The movement of rock from a slope that is so steep the rock continues to move down slope. The movement may be by free falling, bouncing, rolling or sliding.

Roll Out Distance – The furthest slope distance from the toe of the rock cut slope attained by a falling rock.

Standard Deviation – A measure of the variability of collected data. Statistically, it is equal to the square root of the arithmetic average of the squares of the deviations from the mean in a frequency distribution.

Standard Suite – The number of rocks rolled for each slope height and catchment area configuration tested. The standard suite included 100 rocks averaging one foot in diameter, 75 rocks averaging two feet in diameter and 75 rocks averaging three feet in diameter. The “diameter” dimension was measured along the longest axis. The actual diameter dimensions for each size category ranged within plus or minus 6 inches. For example, the 2-foot rocks varied from 1.5 to 2.5 feet in diameter along the longest axis.

Traveled Way – The portion of the roadway for the movement of vehicles, exclusive of the shoulders, berms, sidewalks and parking lanes (Per MUTCD).

EXECUTIVE SUMMARY

Rockfall is the movement of rock from a slope that is so steep the rock continues to move down slope. The movement may be by free falling, bouncing, rolling or sliding. Rockfalls along highways occur where natural slopes or rock slope excavations exist. When rockfalls reach the roadway they are a hazard to roadway users. Hundreds of millions of dollars are spent annually in the U.S. on rock slope maintenance and rockfall hazard mitigation on new and existing slopes. Many states have experienced injuries and deaths caused by rockfall. Annually, the legal claims and litigation costs resulting from rockfall are in the millions of dollars.

A rockfall catchment area is defined as the area between the roadway edge of pavement and the base of a cut slope, used to restrict rockfalls from the roadway. The use of catchment areas (ditches) to contain and restrict rockfall from the roadway is one of the best and most effective rockfall protective measures.

The current practice for designing highway rockfall catchment areas is not consistent throughout the United States. The principle reason no nationally adopted method for designing rockfall catchment areas exists is because only limited research has been conducted to provide designers with the data necessary to make informed design decisions. The limited research has led to many U.S. highway agencies desiring a more rational and better-quantified design criteria for sizing rockfall catchment areas.

Through a pooled fund effort funded by seven State DOT's and the FHWA, the Oregon DOT conducted an extensive research project consisting of rolling roughly 11,250 rocks off vertical; 0.25H:1V; 0.5H:1V; 0.75H:1V; and 1H:1V rock cut slopes of three different heights (40, 60 and 80 feet) into three differently inclined catchment areas (flat, 6H:1V and 4H:1V). The data gathered has been used to develop design charts for dimensioning rockfall catchment areas adjacent to highways.

The design charts are presented in a "practitioner-friendly" form. They can be used to rapidly dimension rockfall catchment areas to meet specific percent rockfall retention requirements. Based on rock cut slope ratio, vertical rock slope height and catchment area slope, the design charts provide an estimate of the required catchment area widths needed to retain up to 99 percent of rockfall. The same design charts can also be used to evaluate the effectiveness of existing catchment areas.

Design guidelines and a step-by-step design procedure are presented and illustrated with three example design problems. In addition, seven actual highway project case study examples prepared by experienced highway agency geotechnical practitioners are provided. They demonstrate the practical application of the design procedure and design charts and/or the use of site-specific rock rolling to aid in the rockfall mitigation design. The case study examples also illustrate other important design considerations, including constructibility and performing benefit/cost comparisons of alternate designs.

With tens of thousands of highway rock slopes in the U.S., many of which are decades old, 100 percent control of rockfall is not possible or economically practical. However, agencies can have greater confidence in making rockfall control design decisions using the results of this research project. Liability exposure will be reduced because design decisions are based on more current, detailed and specific research data.

1.0 INTRODUCTION

1.1 SIGNIFICANCE OF THE ROCKFALL PROBLEM

Rockfall is the movement of rock from a slope that is so steep the rock continues to move down slope. The movement may be by free falling, bouncing, rolling or sliding. See Figure 1.1.

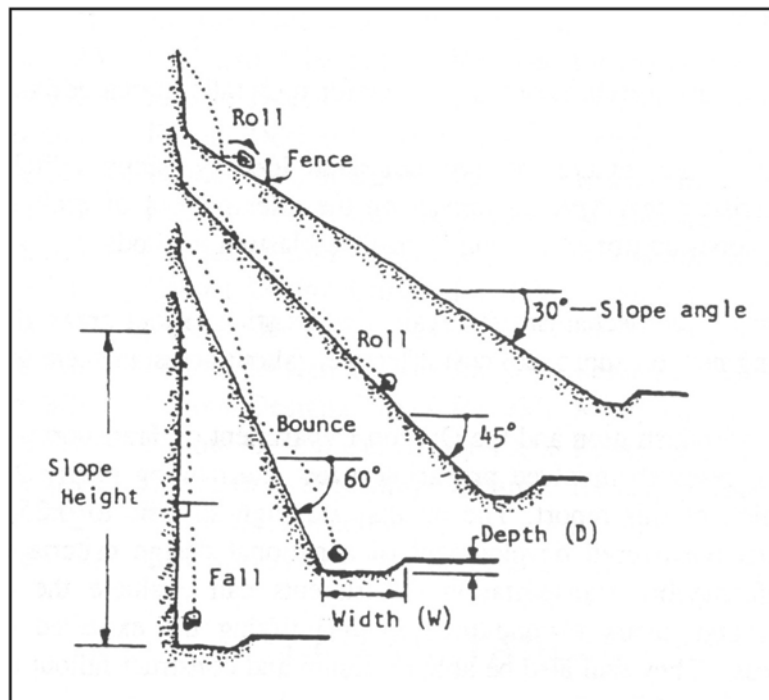

Figure 1.1: Rockfall travel modes (*Ritchie 1963*)

Rockfall is caused by many factors, including unfavorable rock structure (discontinuities), adverse groundwater-related conditions, poor blasting practices during original construction or reconstruction, climatic changes, weathering and tree levering (*Brawner 1994*). Rockfall along highways can occur where natural slopes or rock excavations exist. When such rockfalls reach the roadway they are a hazard to roadway users. Hundreds of millions of dollars are spent annually in the U.S. on rock slope maintenance and rockfall hazard mitigation on existing slopes and as part of reconstruction and new construction projects. Many states have had injuries and deaths caused by rockfall. Annually, the legal claims and litigation costs resulting from rockfall are in the millions of dollars.

1.2 ROCKFALL CATCHMENT AREA DESIGN PRACTICE

A rockfall catchment area is defined as the area between the edge of roadway pavement and the base of an adjacent slope that is used to restrict rockfall from reaching the roadway. The term catchment area is synonymous with ditch, rockfall ditch, rockfall catch ditch and rock fallout area. The use of catchment areas to mitigate rockfall hazards is one of the best and most effective rockfall protective measures.

The current practice for designing highway rockfall catchment areas is not consistent throughout the United States. Transportation agencies have design standards, but they are commonly based on a combination of factors such as economics, constructibility, maintenance and other safety related standards. In some cases, the design of catchment areas is loosely based on decades-old research. The result is a catchment area that may not be as effective at restricting rockfall from the roadway as assumed, or it may be over-designed, leading to unnecessary expenditures and impacts to the environment. Such catchment areas are routinely constructed even though they have not been evaluated or standardized through testing.

The principle reason no nationally adopted method for designing rockfall catchment areas exists is because only limited research has been conducted to provide designers with the data necessary to make informed design decisions. Prior to this research effort, the most comprehensive work done to develop fallout area design guidance was by Arthur M. Ritchie, Chief Geologist with the Washington State Department of Highways. In 1963, the Transportation Research Board (TRB) published a research report by Mr. Ritchie titled “An Evaluation of Rockfall and Its Control” (*Ritchie 1963*). This pioneering work was the first practical and comprehensive study of rockfall from actual highway slopes. The work included rolling hundreds of rocks off highway and state-owned quarry and talus slopes across Washington State. Ritchie measured and recorded the paths and distances the rocks traveled (including production of 16 mm motion pictures). The work culminated in a set of practical design criteria, in table form, that could be used to size the width of rockfall catchment areas based on slope height, slope ratio (angle) and depth of catchment area. This was the first research-based design guidance for safely containing rockfall.

Although pioneering, the Ritchie study was based on data collected from rolling only a few hundred rocks. While the 1963 Ritchie rockfall study was a major step forward, practitioners in years to follow recognized that the Ritchie criteria had some significant limitations (described in Section 2.2). The limitations led many U.S. transportation agencies to support Oregon DOT’s research effort to develop a more current and better-quantified design criteria for sizing rockfall catchment areas.

1.3 RESEARCH PROJECT GOALS

The Oregon DOT research project had three main goals:

1. Investigate the nature of rockfall and identify how slope, catchment area and rockfall properties affect the rockfall retention at the base of vertical, 0.25H:1V, 0.5H:1V, 0.75H:1V,

and 1H:1V slopes - for slope heights of 40, 60 and 80 feet - and catchment area slopes of flat-bottom, 6H:1V and 4H:1V.

2. Develop improved, more precise design guidelines, including “practitioner-friendly” design charts, to assist with designing new or improved rockfall catchment areas that perform as intended with the minimum economic investment and environmental impact.
3. Provide design “flexibility” that allows designing catchment areas that will retain percentages of rockfall ranging up to 99 percent.

Funding for this research effort was obtained through a regional pooled-fund study. The participating State and Federal DOT agencies are listed in the Acknowledgments Section. Together these agencies contributed approximately \$650,000 to accomplish the needed work. With this funding, a test site was developed, the data from rolling over 11,250 rocks was gathered and analyzed, and this report was prepared. The results are a significant step towards the development of an improved design procedure for rockfall catchment areas adjacent to rock cut slopes. The work covered by this report builds and improves on Mr. Ritchie’s original pioneering work.

1.4 REPORT CONTENT SUMMARY

This report contains seven sections and seven appendices. Section 1 provides an introduction and defines the rockfall problem and goals of the research project. Section 2 describes past rock rolling research, including the ODOT 1994 pilot study which developed rockfall catchment area design charts for 0.25H:1V slopes. Section 3 summarizes the results of the more recent expanded rock rolling project conducted to develop catchment area design charts for additional slope angles ranging from vertical to 1H:1V. Section 4 presents catchment area design guidelines and worked example problems. Section 5 presents the full suite of design charts in an easy to use “practitioner-friendly” format. Section 6 presents summary conclusions and a listing of further research needs. Section 7 lists the report references.

Appendix A contains the summary histograms of the field data for the tested Ritchie ditch. Appendix B presents the entire set of rock rolling field data in tabular form for all the rock rolling tests. Appendix C contains the rockfall impact distance histograms. Appendix D contains the rockfall roll out distance histograms. Appendix E presents the rockfall energy data collected for the 0.5H:1V and 0.75H:1V test slopes. Appendix F presents the full suite of catchment area percent rockfall retention graphs. Appendix G contains seven case study application examples illustrating practical application of the design charts and/or the use of site-specific rock rolling to aid in the rockfall mitigation design in actual projects.

1.5 PROJECT BENEFITS

With information provided in this design guide, practitioners can either design new catchment areas or evaluate the effectiveness of existing catchment areas, and they can justify the expense of widening a catchment area based on the improved effectiveness that will be realized. They will also be able to design and construct catchment areas that will have a predictable rockfall retention capacity. The design charts are presented in a “practitioner-friendly” form that can be used to rapidly size rockfall catchment areas that satisfy specific rock catching/retention requirements. Based on cut slope angle, cut slope height and catchment area slope, the design charts estimate the required catchment area widths that will retain percentages of rockfall ranging up to 99 percent.

It is important to note that with tens of thousands of highway rock slopes in the U.S., many of which are decades old, 100 percent control of rockfalls is not possible or economically practical. Nonetheless, with the results of this research project, agencies can have greater confidence in making rockfall catchment design decisions. Liability exposure should be reduced because design decisions are based on more current, detailed and specific research data.

This report documents the test methods, the field work performed, the data gathered, the means of analysis, the research results and sample application of the design charts. The data are presented in both tabular and graphical form in the Appendices. The Appendices also include the detailed project case study application examples. An electronic copy of this report is available through the ODOT Research internet web site <http://www.odot.state.or.us/tddresearch>.

1.6 REPORT TERMINOLOGY

To facilitate reading and understanding of this report, the reader is encouraged to review the Glossary of Terms presented at the beginning of the report (page ix). Readers are also advised that, based on consensus opinion of the project technical advisory committee, the term “rockfall catchment area” has been adopted for use in the report. Catchment area is synonymous with ditch, catch ditch, rock fallout area, rockfall ditch, and rockfall catch ditch. Within the report, the synonymous term “ditch” is sometimes used because that has been the common usage by practitioners, such as “Ritchie ditch.” Also, the term ditch has been used on some of the figures.

2.0 BACKGROUND

2.1 1963 RITCHIE STUDY

Arthur M. Ritchie, Chief Geologist with the Washington State Department of Highways, published his study on rockfall entitled “Evaluation of Rockfall and Its Control” in 1963 (*Ritchie 1963*). The emphasis of Ritchie’s study was to identify the characteristics of rockfall motion relative to a slope’s configuration and height, and to determine the expected impact distance of a falling rock from the base of the slope. He also investigated how to effectively stop a falling rock that had considerable angular momentum once it landed in the catchment area. Based on this work, Ritchie drew several significant conclusions including the following:

1. Irrespective of a rock’s shape or size, the rock’s mode of travel down the slope is a function of the slope angle (refer to Figure 2.1).

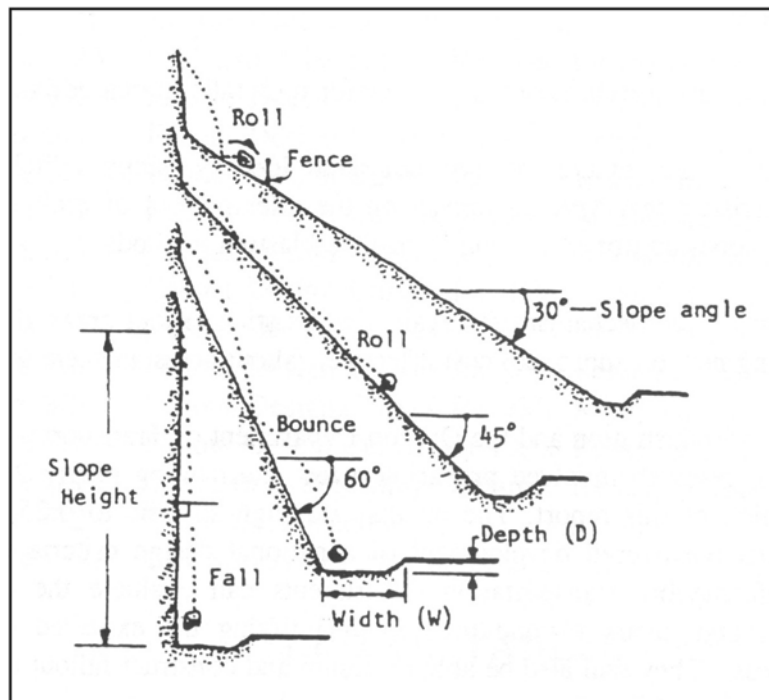

Figure 2.1: Rockfall travel modes (*Ritchie 1963*)

2. On steeper slopes, even though a rock's initial motion is by rolling, after a short distance the rock starts bouncing and then either continues bouncing along the slope or goes into free fall, depending on the slope angle.
3. Rocks that fall in trajectory (free fall) seldom give a high bounce after impact. Instead they change their linear momentum into angular momentum.

In addition, and more significant to the practice of highway design today, Ritchie prepared an empirical design table of recommended minimum rock catchment area width and depth, based on the slope height and slope angle. His table was later adapted into a design chart (refer to Figure 2.2) in the FHWA publication "Rock Slopes: Design, Excavation, Stabilization" (FHWA 1989).

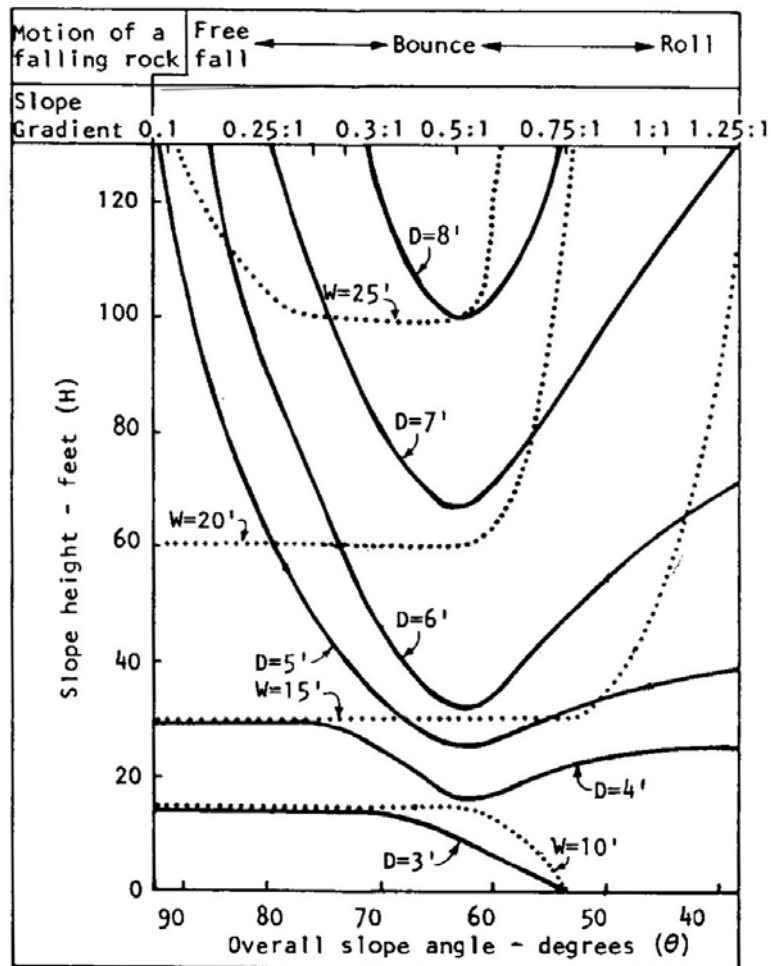

Figure 2.2: Ritchie's rockfall catch ditch design chart (FHWA 1989)

The chart version shown in Figure 2.2 made it easier for designers to interpolate between the cut slope heights, cut slope angles and catchment area (ditch) depths listed on Ritchie's original table.

Almost 40 years later, Ritchie's empirical table (or modified chart version) is still used by numerous state and local transportation agencies to dimension catchment areas. One of the major limitations of the Ritchie design criteria, however, is that Ritchie relied on the use of a deep, flat-bottom ditch with a steep 1.25H:1V foreslope next to the roadway to restrict rocks from rolling up onto the roadway. Such deep, steeply sloped ditches can rarely be used today, since they do not meet current MUTCD/AASHTO roadside clear zone safety requirements. Use of such deep ditches today is typically limited to only the most extreme rockfall hazard locations. As the more modern roadside clear zone safety requirements evolved, the Washington State Department of Transportation (WSDOT) modified Ritchie's original design criteria to allow a more gently sloped (6H:1V) catchment area as an alternate to the deep ditch design. The current 2001 WSDOT design criteria, contained in the WSDOT Roadway Design Manual, are shown on Figure 2 of the Washington State case study application example in Appendix G.

Subsequent to Ritchie's study, D'Appolonia, California DOT (Caltrans), and Evans have completed additional rockfall research work (*D'Appolonia 1979, McCauley, et al. 1985, Evans 1989*). In addition to these field studies, several rockfall computer simulation programs have been developed that can help predict the catchment area requirements. These programs were developed by Evert Hoek (consultant), Shie-Shin Wu (North Carolina DOT), and Tim Pfeiffer (Colorado and Oregon DOT, consultant) (*Hoek 1987, Wu 1987, Pfeiffer and Higgins 1990*). These programs are quite useful in predicting rockfall trajectories when detailed slope information is available. Pfeiffer's program "Rockfall" was used to evaluate catchment area configurations for this study.

2.2 LIMITATIONS OF RITCHIE RESEARCH

Pioneering as it was, the Ritchie study was based on data collected from rolling only a few hundred rocks. While the 1963 Ritchie rockfall study was a major leap forward, practitioners in years to follow recognized that the Ritchie criteria had some significant limitations. These include:

1. The Ritchie table always gives the same required catchment area width and height for a given slope height and slope ratio and does not provide a means for designing for varying percent rockfall retention levels based on a benefit/cost approach.
2. The Ritchie catchment area design is based on providing a catchment area wide enough that a rockfall's initial impact will be within the catchment area. The design relies on a 3- to 8-foot deep flat-bottom catchment area with a steep 1.25H:1V foreslope adjacent to the roadway to restrict rocks from rolling onto the roadway. Such steep-sided roadside catchment areas do not provide a recoverable slope for errant drivers and are not consistent with current roadside safety clear zone design standards. These catchment areas require some form of guardrail or

barrier on the road shoulder to keep vehicles from falling into the ditch and possibly overturning.

3. The Ritchie rock rolling was done primarily on “rough” non-presplit highway and quarry slopes and natural slopes, containing numerous launch features. Today’s highway slopes are predominantly developed using controlled blasting techniques (presplit or cushion blasting) and thus are “smoother” with fewer launch features than those in the Ritchie study.

2.3 ODOT’S 1994 PILOT STUDY FOR 0.25H:1V SLOPES

During 1992-1994, ODOT, supported by FHWA, conducted an initial pilot research study at their Krueger Quarry Rockfall Test Site to gather rockfall performance data and to determine the value of this type of research. The study gathered data from rolling rocks down 0.25H:1V rock cut slopes of three different heights (40, 60 and 80 feet) into three differently inclined catchment areas (flat, 6H:1V and 4H:1V). See Figure 2.3.

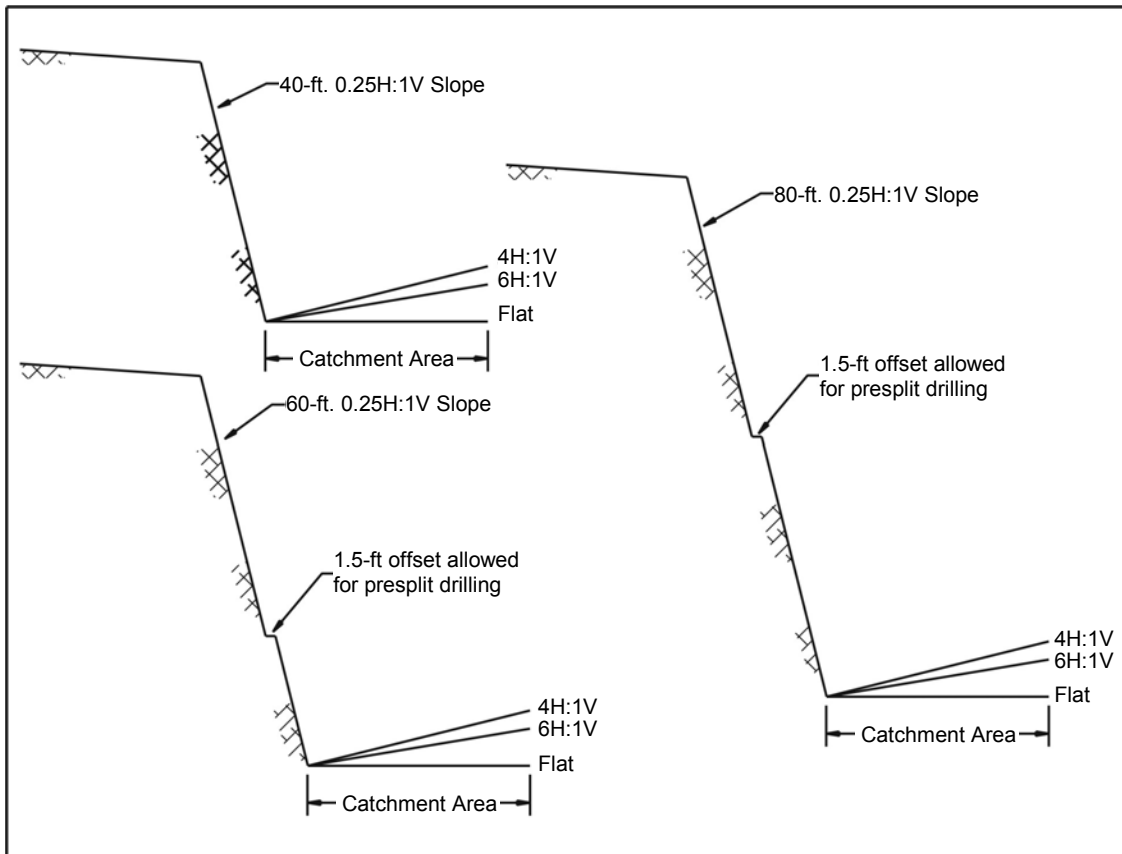

Figure 2.3: Tested slope heights and catchment area configurations (Pilot Study)

A report based on this work entitled “The Nature of Rockfall as the Basis for a New Catchment Area Design Criteria for 0.25H:1V Slopes” was published in 1994 (*Pierson, et al. 1994*). The report number is FHWA-OR-GT-95-05.

Several worthwhile results were realized by the pilot research effort. Rockfall frequency histograms were developed that showed the rockfall retaining ability of catchment areas of a particular width and catchment area slope. This information is important when decisions need to be made on rockfall mitigation at a site. Quantifying the potential for a rockfall to reach the roadway allows designers to consider how much benefit will be realized by a certain investment in construction dollars. When assessing existing sections of highway, this information is also useful for preparing a more precise catchment design, based on a benefit/cost analysis.

In the beginning, the research team speculated on the behavior of rockfall to formulate assumptions for the experimental designs. Without prior rockfall testing frequency to rely on, it was unknown what characteristic shape the distribution curves would take or how many rocks would have to be rolled to obtain one. The testing began with the assumption that the measurements recorded would provide the information required to develop a new design guideline for 0.25H:1V slopes.

The data obtained convinced the team that the level of effort in the pilot study was correct. Early on it became apparent that a sufficient number of rocks were being rolled to establish characteristic distributions. In fact, most conclusions probably could have been drawn based on a smaller data set. To be certain however, the research team rolled a “standard suite” of 250 rocks from each slope height and into each catchment area slope tested. A combination of graphical and statistical techniques provided an appropriate level of analysis.

When constructing new rockfall catchment areas associated with new or improved alignments, or when modifying existing catchment areas to reduce the risk of rockfall related incidents, a goal for rockfall control is usually followed. Normally, this goal is established to provide less than 100% control. Costs associated with 100% rockfall protection are usually unreasonably high: the acquisition of the required right of way, large excavation and construction cost and adverse environmental impact usually cannot be justified.

If the rockfall mitigation measure selected is to construct or improve a catchment area, then the probability of a rock escaping or clearing the catchment area must be included in the risk analysis. Using the results of the pilot research project, the research team was able to develop design guideline charts. These charts can be used to evaluate the likelihood of a rock reaching the roadway for a given catchment area of a particular dimension at the base of a 0.25H:1V slope. Designers now had a quantitative tool with which to determine the percentage of rocks they wish to retain. The design charts constituted a major advance in the “rational” design of rockfall catchment areas.

2.3.1 1994 Survey of Rockfall Catchment Area Design Practice

As an initial part of the 1992-1994 pilot project, a survey was conducted of all the state DOT’s and federal agencies to determine what their method of designing (sizing) rockfall catchment

areas was and whether there was any standardization of design across the country. Thirty-one agencies responded. The questionnaire asked what their design standard/guideline was; how frequently they deviated from their standard; and what was their opinion of the Ritchie criteria.

Twelve agencies responded that they used the Ritchie criteria as their design standard. Of those agencies using the Ritchie criteria, most felt that it was adequate, but almost half felt it was conservative. Nine agencies had some other design standard, with three of these using the computerized Colorado Rockfall Simulation Program (CRSP) for sizing fallout areas.

Nearly a third of the respondents (10) indicated that they had no catchment area design standard. Most of these represented states where rockfall is a rare occurrence. Detailed survey results are tabulated in Pierson, et al 1994.

2.3.2 Comparison to a Ritchie Test Catchment Area (Pilot Study)

A.M. Ritchie published his pioneering work "Evaluation of Rockfall and Its Control" in 1963 (*Ritchie 1963*). For many states, it remains the basis for rockfall catchment area design. As part of the initial pilot research effort, 275 rocks were rolled from an 80-foot high 0.25H:1V slope into a "Ritchie" catchment to determine its effectiveness. For comparison purposes, the tested Ritchie catchment area was dimensioned according to the modified Ritchie design chart (see Figure 2.2) contained in the FHWA Rock Slopes Manual (*FHWA 1989*). The Ritchie catchment area dimensions obtained from the design chart are slightly different than some of the dimensions on Ritchie's empirical table due to the curve smoothing done when formulating the chart. For a 60- to 80-foot high, 0.25H:1V slope, Ritchie's original table calls for flat-bottom catchment area with dimensions of 20 feet wide and 6 feet deep with a 1.25H:1V foreslope. The modified FHWA chart gives dimensions of 22 feet wide and 6.25 feet deep with a 1.25H:1V foreslope.

The intent was to construct a test catchment area consistent with the modified FHWA chart. However, this did not occur. Due to a construction error, the "as-built" dimensions of the tested Ritchie catchment area were 24 feet wide, 6.5 feet deep with a flat bottom and 1H:1V foreslope (refer to Figure 2.4). This is wider and deeper and contains a steeper foreslope. Based on observed rockfall behavior, these modifications should make the tested ditch more effective than a standard Ritchie ditch.

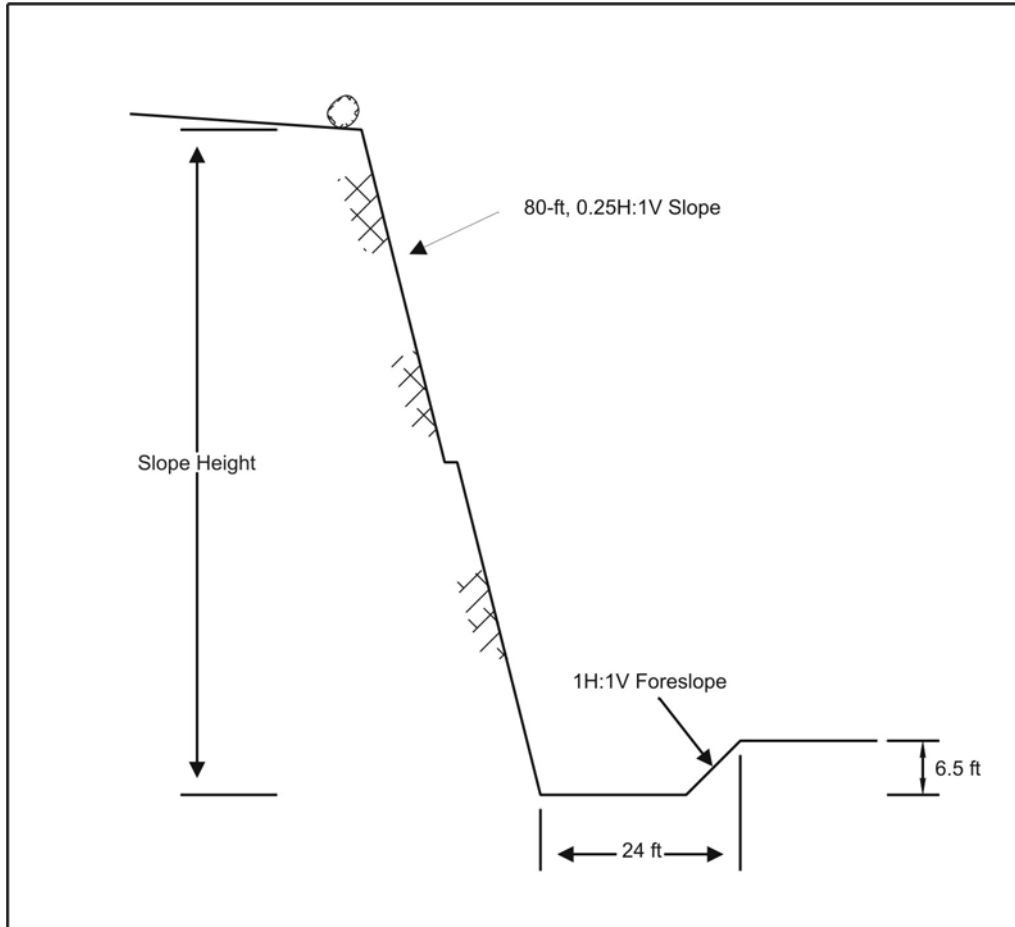

Figure 2.4: Tested Ritchie catchment area shape and dimensions

Figure 2.5 shows the comparison between the tested Ritchie catchment area data and the data obtained for the 80-foot high 0.25H:1V slope, for both the 4H:1V and 6H:1V catchment areas. Upon examination, the tested Ritchie catchment area compares favorably with both the 6H:1V and 4H:1V catchment area slopes. Predictably, the average impact distances (where the falling rock first hits the catchment area) for the three catchment area slopes are almost identical. Regarding roll out retention, the tested Ritchie catchment area showed a 2- to 3-foot reduction in roll out distance compared to the 6H:1V and 4H:1V catchment area slopes. Figure 2.6 shows the cumulative percentage of rocks retained for the tested Ritchie catchment area.

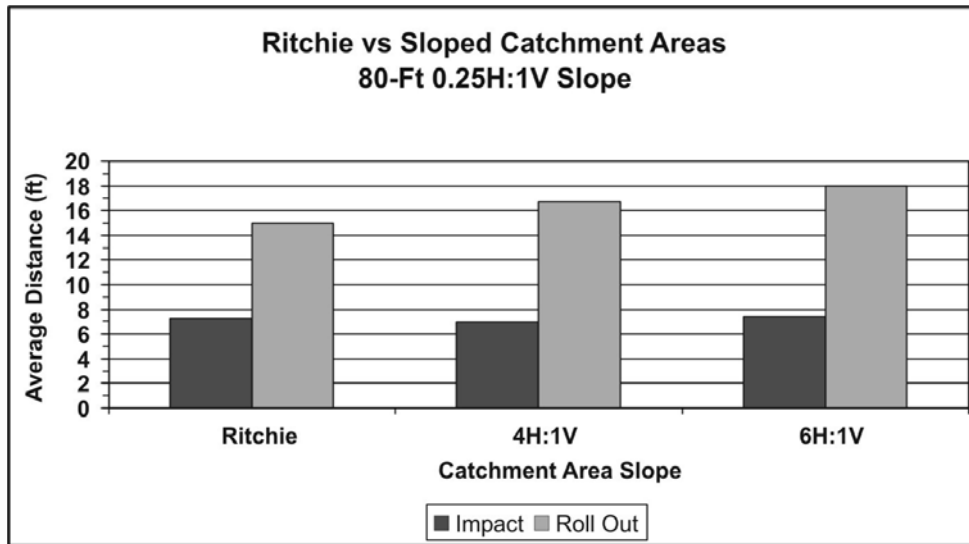

Figure 2.5: Comparison of tested Ritchie to 4H:1V and 6H:1V sloped catchment areas

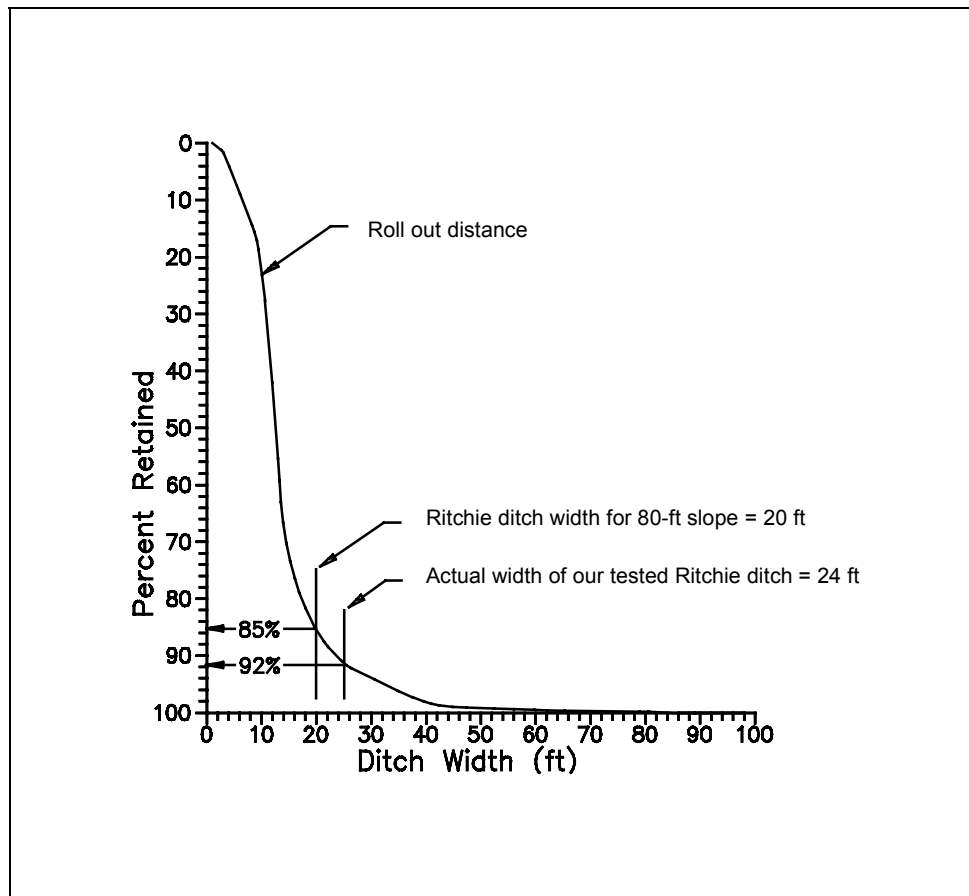

Figure 2.6: Cumulative percentage rockfall retained for tested Ritchie catchment area

Although the Ritchie shaped ditch used for testing was wider, deeper and contained a steeper foreslope than a standard Ritchie ditch, eight percent of the rocks were still able to escape the catchment area; 92 percent were retained. Had the catchment area been designed to a Ritchie width of 20 feet, per the original Ritchie design table, 41 rocks, or about 15 percent of the total, would have escaped the confines of the catchment area. In other words, the design would have provided a retention value of 85 percent. Of the 41 rocks, three rocks would have impacted beyond the catchment area and the remaining 38 would have landed within the catchment area and rolled through. This finding indicates that the original Ritchie guidelines are not as conservative as previously thought. Frequency histograms for the tested Ritchie catchment area are shown in Appendix A.

A Ritchie catchment area reduced the average roll out distances versus the 6H:1V and 4H:1V sloped catchment areas, but would have allowed 15 percent of rocks to reach the roadway. The most effective features of a Ritchie ditch are the overall depth and the steep 1.25H:1V foreslope. These features, however, are rarely incorporated into modern highway catchment areas primarily because catchment areas this deep, and with such a steep foreslope, offer no chance of recovery for an errant driver. The catchment area does not meet current roadway design standards for roadside clear zones.

2.3.3 Comparison with Computer Rockfall Simulation (Pilot Study)

Several state transportation departments now use computer simulation of rockfall as a tool to help in designing for rockfall. The most commonly used computer program is the Colorado Rockfall Simulation Program (CRSP), (*Pfeiffer and Higgins 1990*). This program provides estimates of probable bounce heights and velocities for rockfall. Recently, additional statistical data have been added providing probability distributions for velocity, energy and bounce height. The program is applicable to almost all slope configurations. It is more flexible than design criteria that require slopes of given configurations. Simulation, however, requires detailed site condition and slope geometry input data and assumptions; therefore accuracy varies, depending on the quality of the input data.

As part of the pilot research effort, rockfall simulation was used to aid in planning, by providing ranges of expected values for the 0.25H:1V slopes. It was found that the computer simulations tended to under-predict the rockfall roll out distance for the 80-foot slope height and over-predict the roll out distance for the 40-foot slope height.

Histograms of roll out distances for both the simulation data and the field data showed most of the rocks stopping close to the slope and a small percentage with very large roll out distances. Figure 2.7 shows a comparison of the actual field data versus the computer simulation prediction for the roll out distances. The data used is where 90 percent of the rockfall would be expected to have come to rest.

The data from the field tests was also compared to computer simulation data to evaluate the accuracy and applicability of the computer model simulations to extrapolate beyond the tested 40- to 80-foot slope heights. Computer simulation had previously been compared to rockfall on

less steep natural slopes, but data from a controlled study of 0.25H:1V presplit slopes and associated roll out distances were unavailable prior to the ODOT pilot study.

The computer simulation data agreed reasonably well with the field test data. Similar distributions were obtained and the effects of rock size and catchment area slope were also similar. This provided important verification that computer simulations, performed by experienced geotechnical personnel, could be used as a design tool for rockfall catchment areas when extensive field-testing is not practical or nonstandard slope or catchment area shapes are proposed.

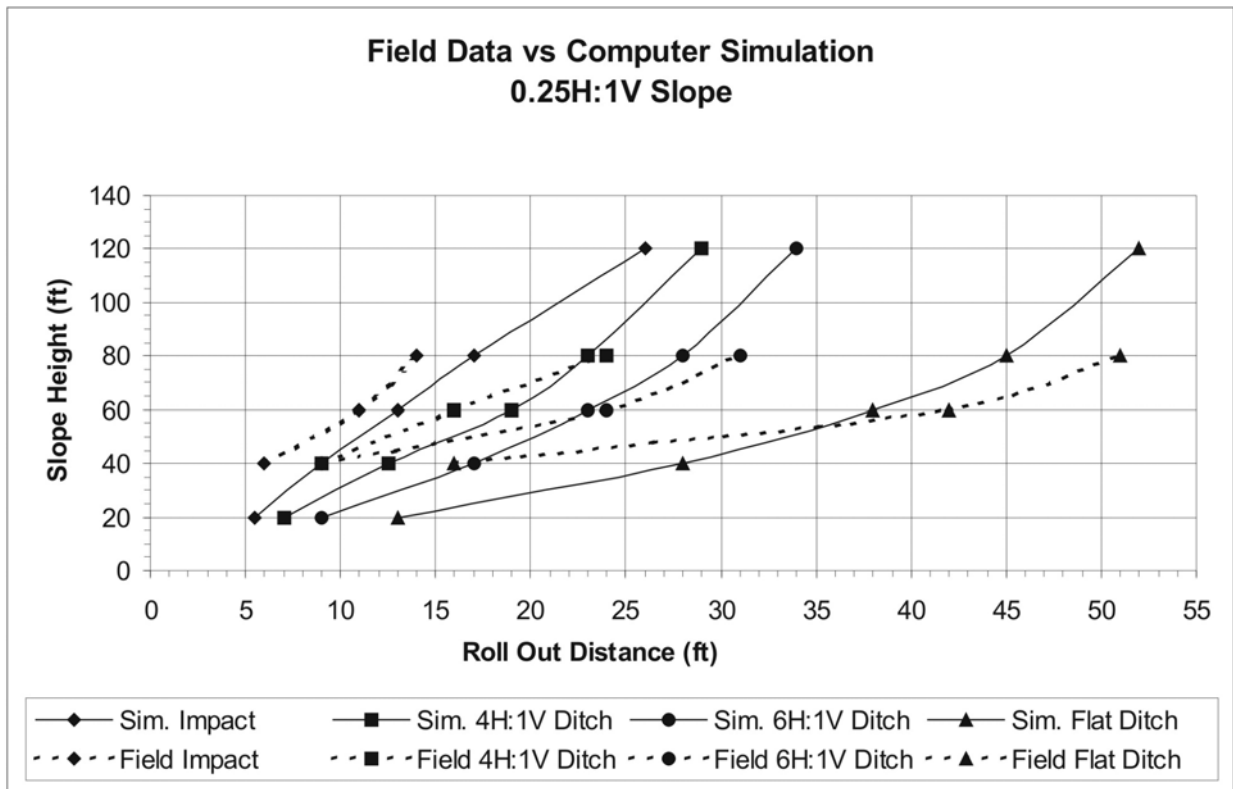

Figure 2.7: Field data and computer simulation comparison (0.25H:1V slope)

3.0 FULL SCALE TESTING OF ADDITIONAL SLOPES

The results of the 1992-1994 pilot research effort for the 0.25H:1V slope established the value of this type of research and prompted several State DOT's and the FHWA to participate in the evaluation of several more slope configurations. The additional slopes were tested through a pooled fund research project conducted between 1997-2001.

3.1 RESEARCH SITE TEST COMPONENTS

To conduct the field testing, the Oregon DOT Krueger Quarry Test Site needed to be expanded to accommodate four more slopes: vertical, 0.5H:1V, 0.75H:1V and 1H:1V. All slopes needed to represent the types of conditions encountered adjacent to highways and needed to be at least 80 feet high. The area above the quarry face was relatively flat, making it ideal as a staging area for stockpiling the rock that was to be rolled. Access to the top existed but needed to be improved for all weather use.

A contractor was retained to drill and shoot the various cut slopes and provide the equipment needed to excavate the shot rock and slope the catchment areas. All cut slopes were shot in two 40-foot lifts. The cut slopes that were 0.75H:1V or steeper were developed using controlled blasting (presplitting). The flatter 1H:1V slope was developed using only production blasting. On the presplit slopes, a maximum 1.5-foot offset was allowed between lifts to accommodate the drilling equipment (see Figure 3.1).

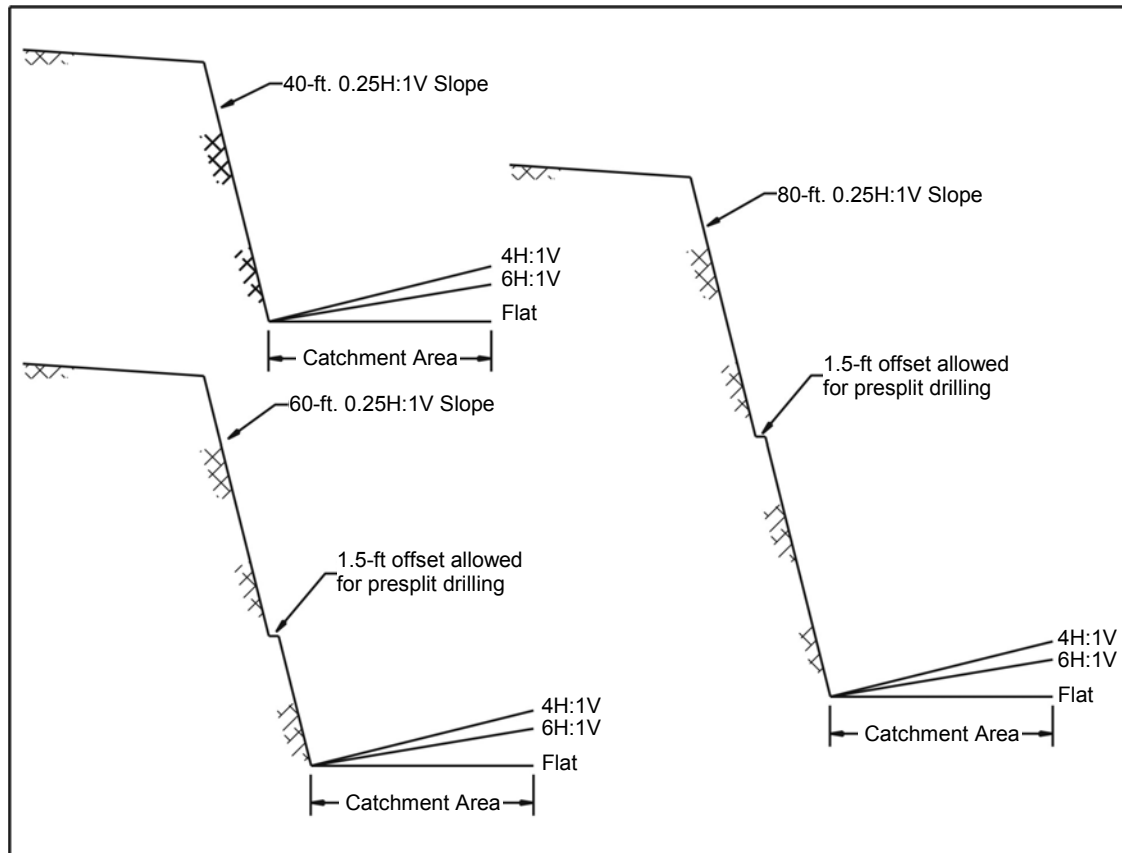

Figure 3.1: Tested slope height and catchment area configurations

For each slope angle, the top lift was excavated to create the first 40-foot high slope to be tested. Once testing was complete, the second lift was shot, but only the top 20 feet was removed to create the 60-foot high slopes. The remaining shot material was subsequently excavated to create the 80-foot high, test slopes. In order to optimize the economy of the research project, several slopes were constructed and tested simultaneously.

Consistent with the 1994 pilot project, three different catchment area configurations were tested for each cut height (Figure 3.1):

- a flat bottom catchment area;
- a catchment area that sloped toward the cut slope at a 6H:1V slope; and
- a catchment area that sloped toward the cut slope at a 4H:1V slope.

These are the configurations most commonly constructed adjacent to highways and are consistent with the current clear zone safety requirements.

The catchment area surface was comprised of shot rock with a minimal percentage of soil. Due to the method of excavation, the steepest (4H:1V) catchment area was tested first for each slope

height. The 6H:1V catchment area and then the flat-bottomed catchment area followed. This excavation method allowed the rockfall impact to occur on a material that would closely approximate conditions that would be encountered at the base of a newly constructed highway rock cut slope. Photos of the test site are shown in Figures 3.2, 3.3 and 3.4.



Figure 3.2: 80-foot high, 0.25H:1V presplit slope (Oregon test site)

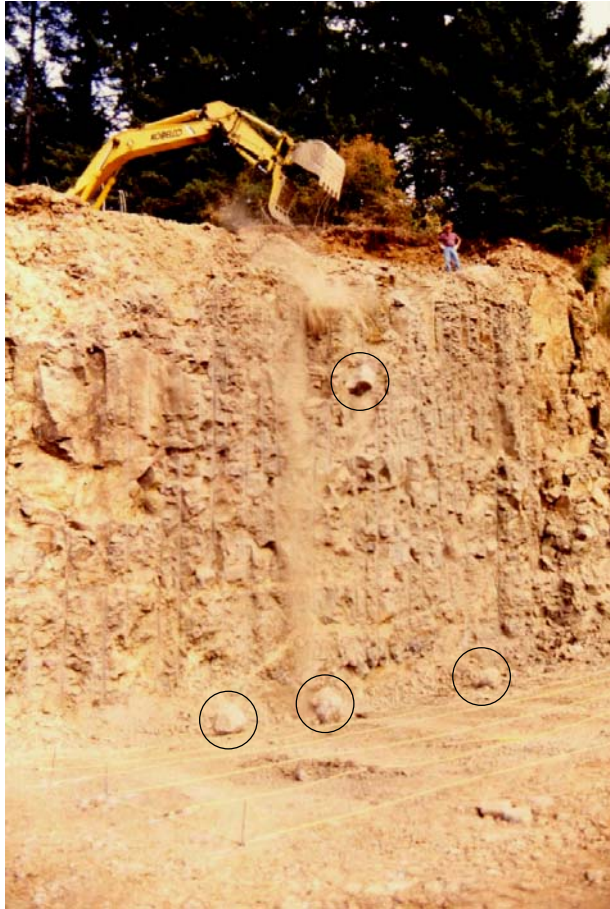

Figure 3.3: Rockfall testing; 40-foot high vertical presplit slope, 2-foot diameter rocks, 4H:1V catchment area foreslope. Circles denote test rocks.



Figure 3.4: Rockfall testing; 40-foot high vertical presplit slope. Circle denotes test rock. Grid lines (middle-right) are for measuring impact and roll out distances.

In all, more than 11,250 rocks were rolled at the research site, with at least 750 rocks rolled for each cut slope angle and height. Each catchment area slope received a “standard suite” of rocks, which included 100 rocks averaging one foot in diameter, 75 rocks averaging two feet in diameter and 75 rocks averaging three feet in diameter. The diameter dimension was measured along the longest axis. The actual dimensions for each size category ranged within plus or minus 6 inches. For example, the two-foot rocks varied from 1.5 to 2.5 feet in diameter along the longest axis.

Two values were recorded for each rock that was dropped: the impact distance and the roll out distance. The impact distance was the measured slope distance from the base of the cut slope to the point where the rock first struck the ground. The roll out distance was the furthest measured distance that the rock attained from the base of the cut slope. The complete field test data are included in Appendix B.

How a rock falls influences where it impacts the catchment area. For example, if a rock strikes a protrusion in the cut face during its descent and is redirected away from the slope, it will have a larger impact distance than if it stays close to the slope during its fall. An additional assumption,

based on experience, was that inclining the catchment area would have some measurable effect on roll out distance. Based on these assumptions the analysis was divided into three primary parts:

1. Slope effects and impact distance;
2. Catchment area slope and roll out distance; and
3. Impact versus roll out distance.

3.2 SLOPE EFFECTS AND IMPACT DISTANCE

Impact distance is defined as the measured slope distance from the base of the rock cut slope to the point where a falling rock first strikes the ground.

A catchment area's slope, whether flat-bottom or inclined, has only slight influence on where a falling rock will first impact the catchment area. Conversely, a rockfall's point of impact can be strongly influenced by cut slope irregularities, commonly referred to as "launch features." These launch features include blasting offsets and other protrusions caused by the breakage properties of the rock and the means of excavation.

At the ODOT test site, even though the slopes tested were relatively smooth and uniform presplit slopes (for the 0.75H:1V and steeper test slopes), some slope irregularities were still present. The combined effects of these features were pronounced enough that certain preferred rockfall paths became prevalent. Figure 3.5 shows a representation of rocks falling from an 80-foot high 0.25H:1V slope and impacting in a flat catchment area. The most common preferred rockfall paths for this slope are labeled 'A', 'B', 'C' and 'D'. At least two factors are key to the development of preferred rockfall paths: the presence of launch features, and increasing slope height.

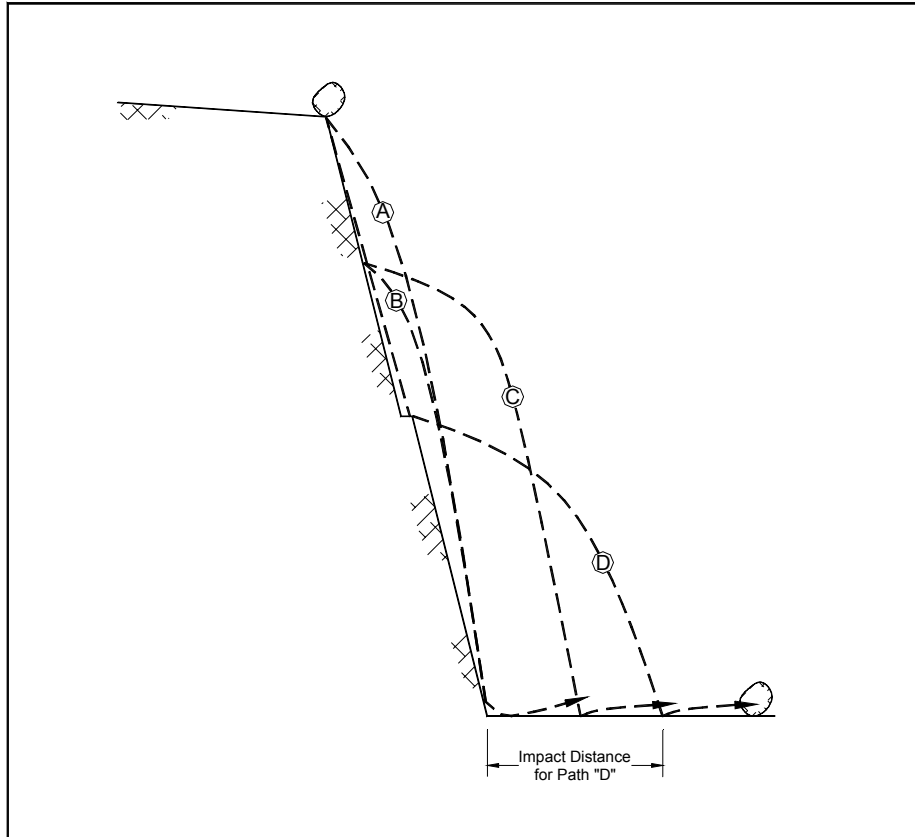

Figure 3.5: Preferred rockfall paths

Rocks that fall along path ‘A’ do not encounter the slope until just before impact, resulting in smaller impact distances measured from the base of the cut slope. Rocks following path ‘B’ strike the slope in two places, but do not strike launch features, thus resulting in a lower impact distance.

Those that encounter launch features on the slope are pushed farther away from the slope and follow paths similar to ‘C’ or ‘D’. “Launched” rocks tend to have greater impact distances, increasing the spread or dispersion of recorded impacts compared to rocks that do not strike launch features. Launch features change a rock’s vertical drop to horizontal displacement. Typically, the higher the rock velocity when it strikes a launch feature the greater the horizontal displacement.

Impact histograms have been developed as a method to show the distribution of data points and data trends. They are useful tools for visualizing the full range of field measurements. Included on the histograms is a cumulative percentage curve that allows practitioners to roughly estimate the percentage of rocks that impacted at a distance less than or equal to the distances shown along the horizontal axis at the base of the figure. Because the horizontal axis is not an actual scale, however, interpolating between the labeled distance values yields only an approximation. These histograms should not be used for design purposes.

Figures 3.6 through 3.8 show impact distance histograms for the 40-, 60- and 80-foot high 0.25H:1V slopes. The histogram for each slope height includes the 825 impact data points from the three catchment area slopes. They provide a graphical representation of frequency, or how often, a certain impact value was recorded. As included here, these figures are composite histograms for all three catchment area shapes tested. The histograms included in the appendices show individual histograms for each catchment area shape. The average impact values calculated from the field-measured data points were 3.5, 5.6 and 6.8 feet for the 40-, 60- and 80-foot high 0.25H:1V slopes, respectively. Because the distances shown along the horizontal axis are not scaled, these values cannot be directly determined from the histograms.

The observed impact results from the test slopes are consistent with observations and experience at actual highway rock cut slopes. This consistency adds credibility to the research results and demonstrates the validity of the findings. The complete set of Impact Distance Histograms is included in Appendix C.

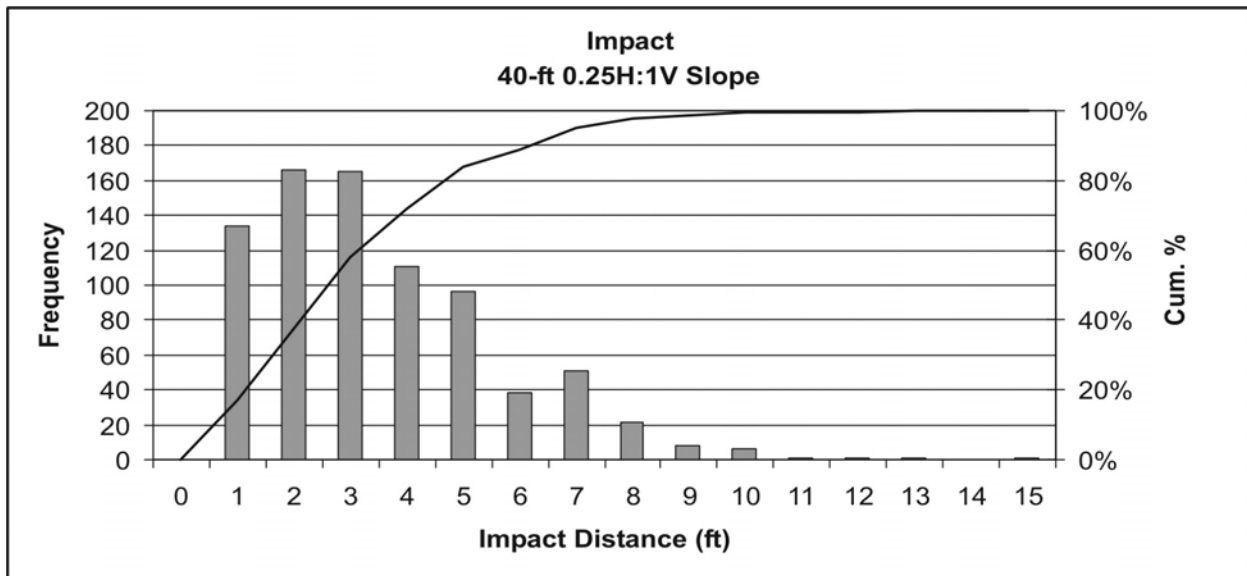

Figure 3.6: 40-foot impact histogram (0.25H:1V slope)

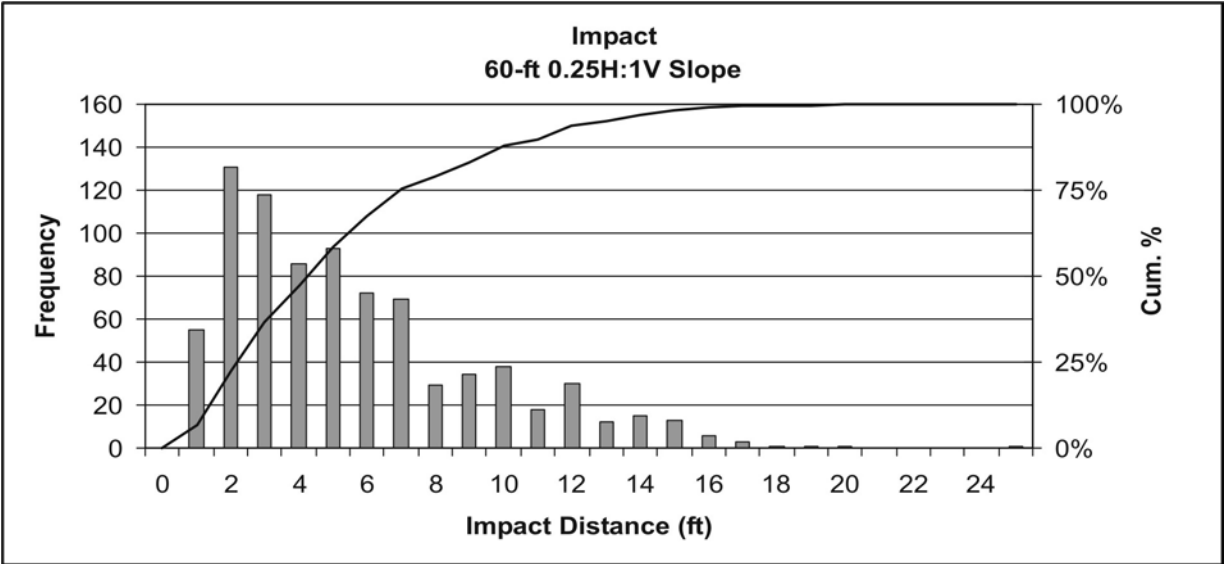

Figure 3.7: 60-foot impact histogram (0.25H:1V slope)

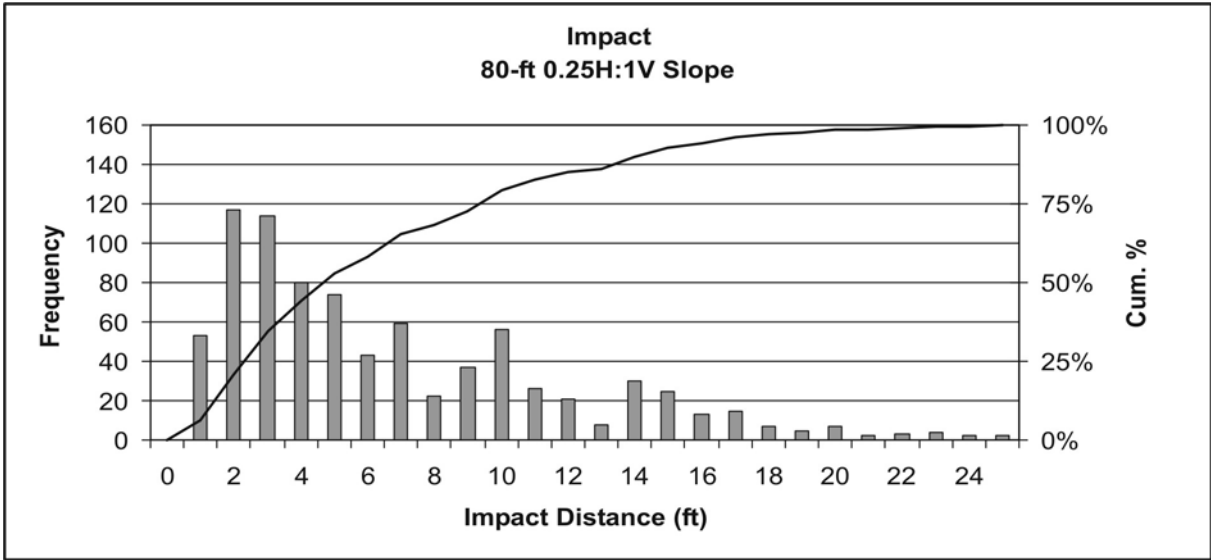

Figure 3.8: 80-foot impact histogram (0.25H:1V slope)

3.3 CATCHMENT AREA SLOPE AND ROLL OUT DISTANCE

Roll out distance is defined as the measured slope distance between the base of the cut slope and the furthest point the rock reaches from the base of the slope. Figure 3.9 shows a rock falling from an 80-foot high, 0.25H:1V slope, engaging a launch feature and impacting a 4H:1V bottom sloped catchment area at point 'A'.

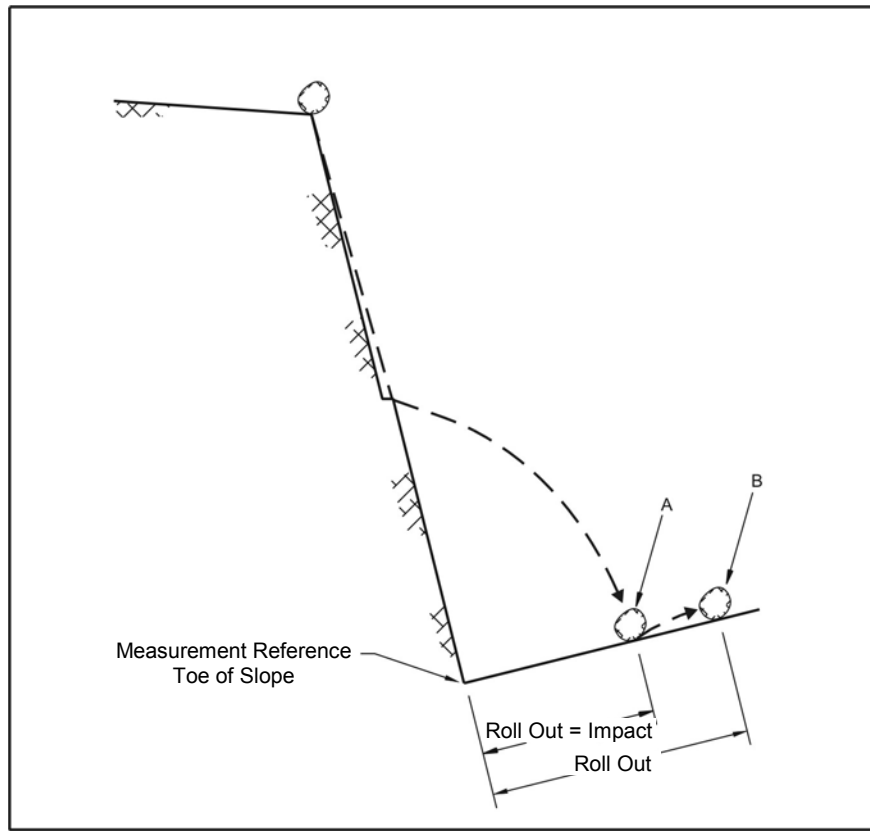

Figure 3.9: Definition of roll out distance

Two outcomes can occur:

- 1) The rock does not move beyond the point of impact, position 'A'. For this case, roll out distance equals impact distance. This outcome includes rocks that roll back toward the toe of the slope from the point of impact.
- 2) The rock impacts at position 'A', then rolls toward the road attaining a maximum distance from the base of the slope at position 'B'. In this case the roll out distance is greater than the impact distance.

Two conclusions can be drawn from rockfall behavior observations: 1) steeper sloped catchment areas tend to reduce roll out distance; and 2) higher slopes typically produce larger average roll out distances. Figure 3.10, compiled from the 0.25H:1V slope data, and Figure 3.11 from the 1H:1V slope data, illustrate these relationships well. Using the flat sloped catchment area as a basis, the average roll out distance for all heights combined was reduced by 37% in the 6H:1V sloped catchment area and 51% in the 4H:1V sloped catchment areas for the 0.25H:1V slope and by 48% (6H:1V) and 66% (4H:1V) for the 1H:1V slope.

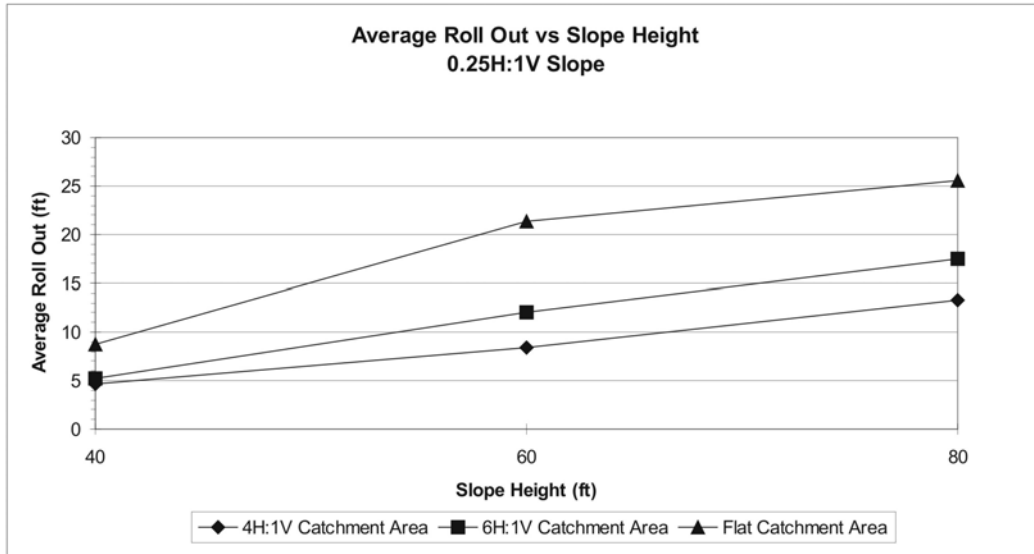

Figure 3.10: Average roll out distance vs. slope height (0.25H:1V slope)

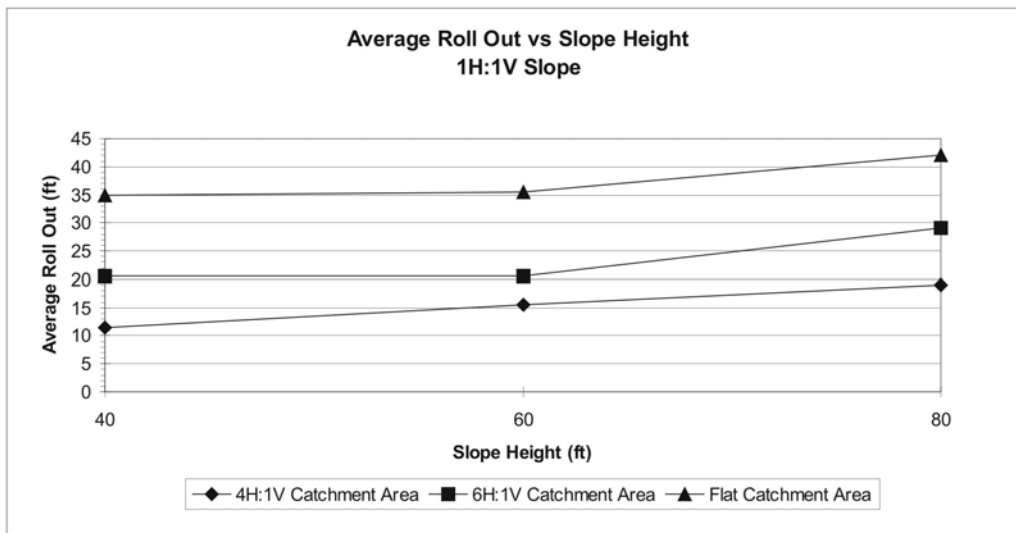

Figure 3.11: Average roll out distance vs. slope height (1H:1V slope)

Figures 3.12 through 3.14 show the roll out distance histograms for the 80-foot high, 0.25H:1V slope, and the three different catchment area slopes. When comparing the data trends for the different catchment areas, it is important to note that the maximum distances shown along the horizontal axes are different from one another. These histograms clearly demonstrate that steeper catchment areas restrict roll out considerably. For example, the average calculated roll out distances are 20, 16 and 12 feet for the flat-bottomed, 6H:1V and 4H:1V sloped catchment areas, respectively. Because the horizontal axis is not a scaled axis, these values can only be estimated

from the cumulative percentage curves. As with the impact distance histograms, the roll out distance histograms should not be used to establish design values. The complete set of Roll Out Distance histograms is included in Appendix D.

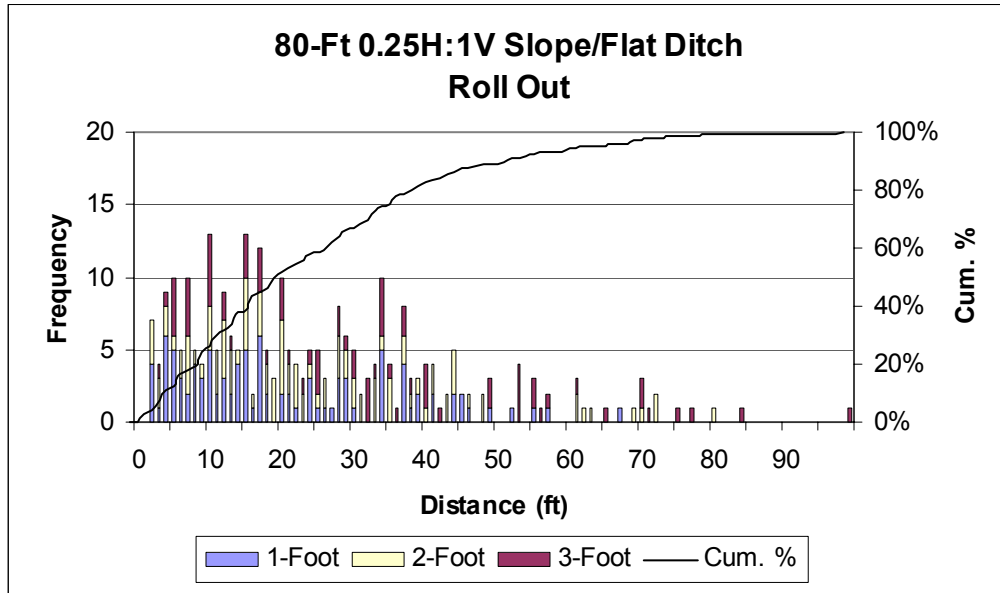

Figure 3.12: Roll out histogram, 80-foot slope – flat catchment area

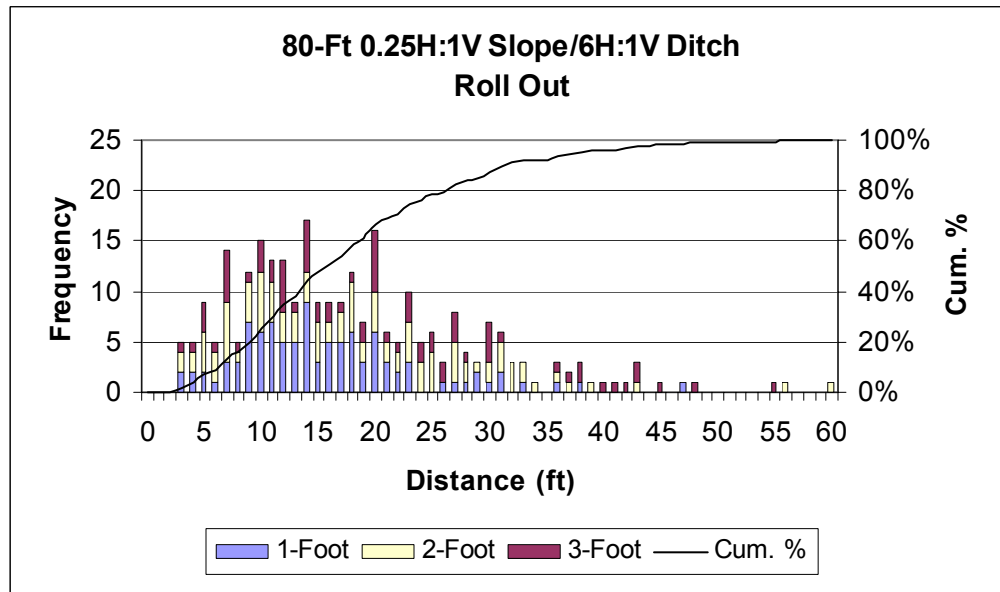

Figure 3.13: Roll out histogram, 80-foot slope – 6H:1V catchment area

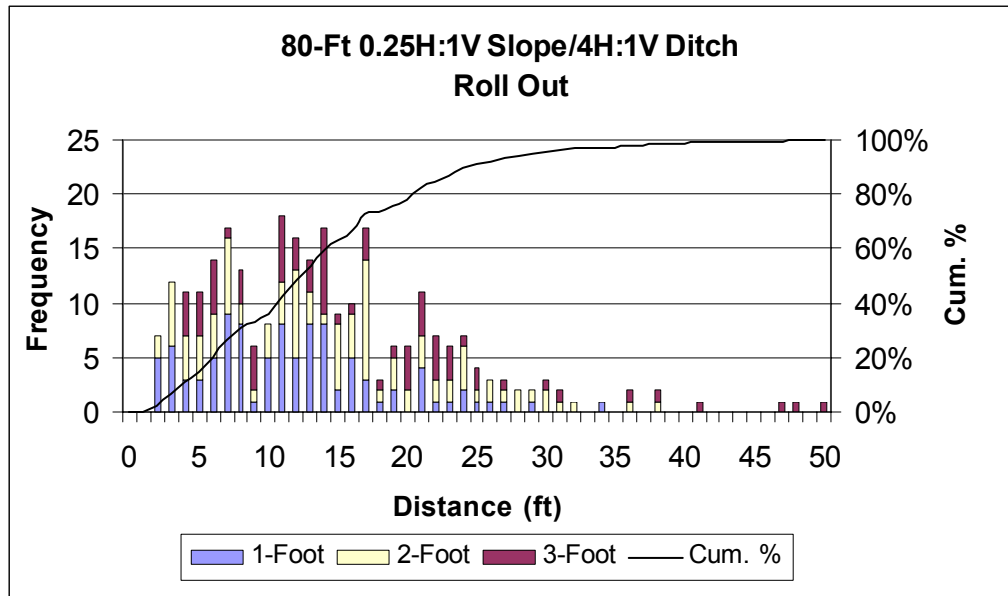

Figure 3.14: Roll out histogram, 80-foot slope – 4H:1V catchment area

3.4 IMPACT DISTANCE VERSUS ROLL OUT DISTANCE

Impact and roll out distances were recorded for each rock. Each cut slope angle exhibits a specific relationship with these data. The basic relationships of preferred path relative to the toe of the slope can be interpreted from these data, as discussed below. A comparison of impact versus roll out distances indicates that higher slopes and flatter catchment areas tend to have data that are more widely scattered or variable. The data show that the impact distances tend to be greatest for slopes between 0.25H:1V and 0.5H:1V where rockfall trajectories are significantly altered when the rocks strike the slope during falling. Striking the slope launches the rocks away from the slope, increasing impact distance. Large roll out values are also possible, especially if a rock strikes the cut slope near the base, which can result in most of the falling rock’s translational momentum being changed into rotational momentum. The largest roll out value (99 feet) was recorded on an 80-foot high, 0.25H:1V slope.

On vertical slopes, falling rocks rarely strike the slope in trajectory. They typically drop undisturbed into the catchment area. Angular momentum is not imparted to the falling rocks, which results in small roll out values. This is demonstrated in the collected data for each rock, which include numerous measured impact and roll out values that are similar.

On flatter slopes (0.75H:1V and flatter), where rocks are rolling down the cut slope, the impact distances are lower, with most rocks entering the catchment area very near the base of the slope. Movement out into the catchment area is due primarily to roll out. Restricting these rockfalls from the roadway is accomplished by energy dissipation due to gravity and friction as the rock rolls through the flat bottom or up the inclined foreslope of a sloped catchment area.

An easier way to understand the variability in the rockfall data is to use a statistical quantity called standard deviation. Put simply, the standard deviation is a measure of data scatter. A small standard deviation means there is little scatter between measurements and most values are clustered around the average. A larger standard deviation means there are larger differences between measurements, and values are widely scattered about the average. Two sets of data may have the same average value but have very different standard deviations.

An examination of the standard deviation can help explain the relationship between impact and roll out. Figure 3.15 shows the standard deviation of impact distance plotted against slope height. All three catchment area slopes are shown. In each case, impact distance becomes more variable as the slope height increases. Since impact distance is independent of catchment area slope the curves cross each other at various points.

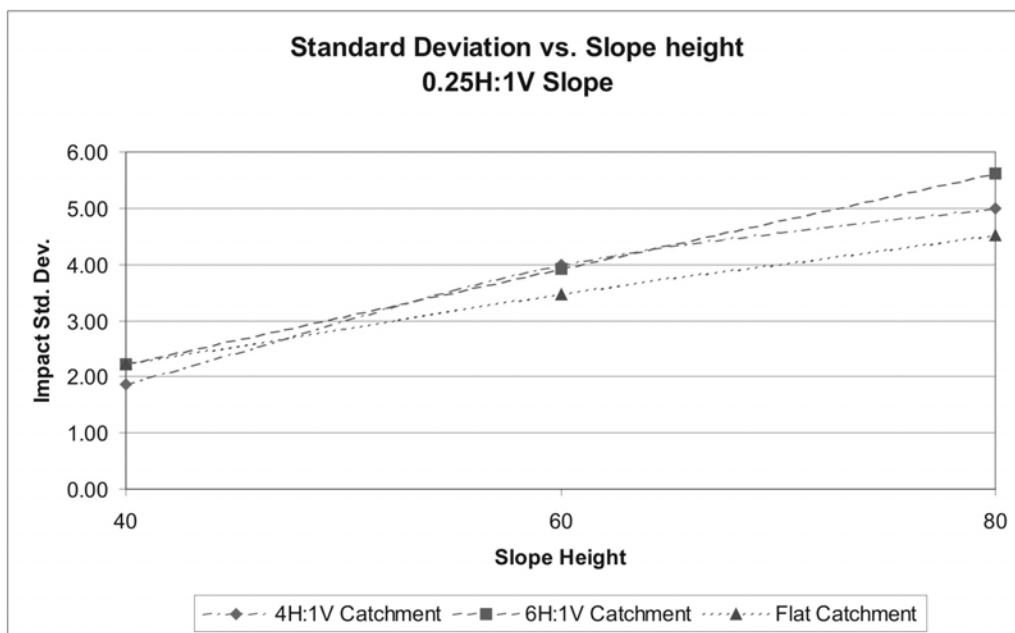

Figure 3.15: Standard deviation of impact distance (0.25H:1V slope)

Figure 3.16 shows the standard deviation of roll out distances plotted against slope height. In each case, roll out distance becomes more variable with both an increase in slope height and flattening of the catchment area. This relationship is particularly clear for flat catchment areas at greater slope heights.

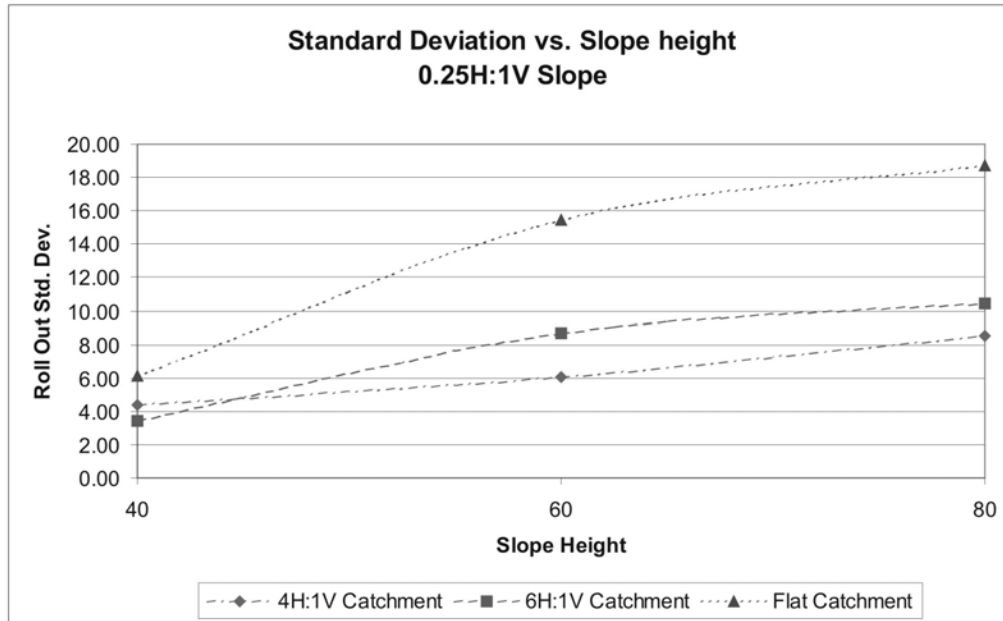

Figure 3.16: Standard deviation of roll out distance (0.25H:1V slope)

From these two graphs one can conclude that higher slopes produce impact distances that are more variable and that roll out distance is more variable in both higher slopes and flatter catchment areas. Because of these relationships, higher slopes typically require wider and/or steeper catchment areas in order to provide an equivalent degree of protection. However, because of the non-linear relationship between catchment area width and the percent of roll outs that can be contained, simply increasing catchment area width yields a diminishing return. This concept is clearly demonstrated by the percent retention graphs presented in Section 4.2 and Appendix F.

3.5 ROCKFALL ENERGY DATA

Further into the research project, an additional research item was added to collect rockfall energy data. The Technical Advisory Committee felt the information would be a valuable contribution to future research efforts such as testing various mitigation designs to failure and in comparing computer simulated results to real data. For example, rockfall mitigation measures such as catch fences or Jersey (GM) barriers could be instrumented, and the impact energies required to fail the systems could be determined. The rock rolling energy data would be useful in determining which slopes, slope heights and rockfall sizes would be appropriate candidates for these measures.

Selected rockfall energy data were recorded for the 0.5H:1V and 0.75H:1V slopes from the three heights tested. Sets of reference marks were placed on the slopes just above the base of the slope. Representative rocks within the one, two, and three-foot categories were weighed and video taped (VHS format at 30 frames/second) during rolling. By analyzing the video data, the

time it took the rolling rocks to pass through the reference marks was used to determine the rockfall velocity. The weight and velocity data were used to calculate the kinetic energy of the falling rocks upon entering the catchment area.

The energy information recorded represents a small population of data points. Because of the small numbers sampled, the results are limited. Still, the results show intuitive trends. The rockfall energy graphs are included in Appendix E. A sample graph is shown in Figure 3.17. As shown on the figure, the energies ranged from a low of 156 ft-tons to a high of 1,858 ft-tons. The difference is due primarily to the weights of the rocks that were tested. The weight of a rock increases exponentially by the third power of its radius. The rocks in this case varied in shape and were in the “one-foot” category, where rocks ranged in diameter from 0.5 to 1.5 feet.

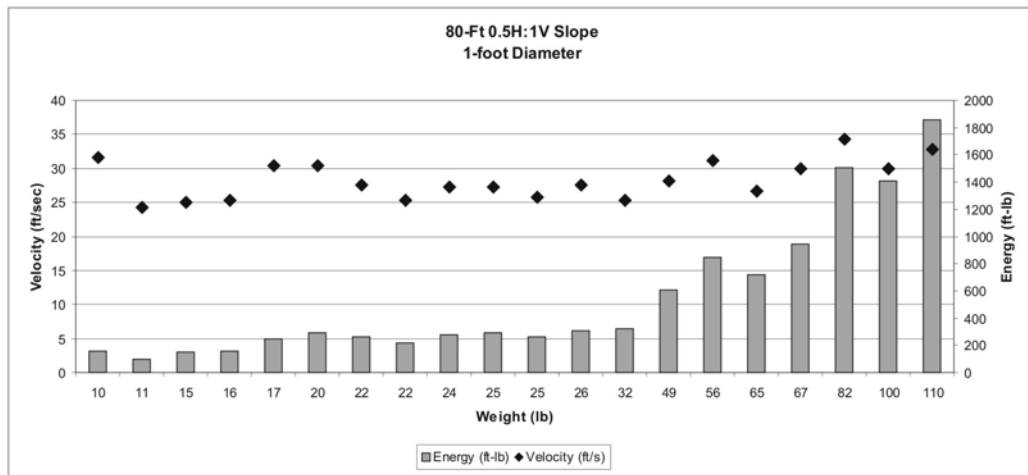

Figure 3.17: Energy data for 1-foot rocks (80-foot high, 0.5H:1V slope)

The rockfall velocities are a function of cut slope angle and height and the amount of time the rocks are in contact with the slope. Velocities tended to be within a narrow range of values for each of the two slope angles tested, with slight increases as the slope height increased. The variations are primarily attributable to the path taken by the rocks during descent.

In general, when in contact with the slope, friction slows the rocks and lowers the resulting energies. Because the rocks are less often in contact with the slope (bouncing not rolling) on the 0.5H:1V slopes, the resulting velocities and energies are higher than for the 0.75H:1V slopes. This relationship explains why rolling rocks can come to a complete stop on flatter slopes and not make it to the catchment area.

4.0 DESIGN GUIDELINES AND APPLICATION EXAMPLES

4.1 DESIGN GUIDELINES

Even though rockfall-related traffic accidents receive an inordinate amount of publicity relative to other types of traffic accidents, they are still a rare event. The probability of being involved in a rockfall accident is quite low. For a rockfall-related accident to occur, several conditions must be satisfied.

1. A rockfall event must take place.
2. The rockfall must enter the roadway by clearing or rolling through the catchment area.
3. The rockfall must strike, or be struck by, a vehicle, or cause an accident due to the vehicle maneuvering to avoid the rockfall.

A number of factors play a role in determining the rockfall hazard inherent to a particular slope. An accepted methodology for evaluating and quantifying the rockfall hazard potential is the Rockfall Hazard Rating System (RHRS) (*Pierson, et al 1989*). The system evaluates site conditions that include traffic density, geologic conditions, block size and rockfall history, among others. The RHRS provides a hazard rating of any number of sites relative to each other, enabling a transportation agency to prioritize how and where to spend their limited safety improvement and construction budget.

Because the likelihood of personal involvement in a rockfall event (and resulting injury) is low, the design goal of rockfall retention is normally less than 100%. The unreasonably high cost associated with 100% rockfall protection can not usually be justified by the risk to highway users. If rockfall mitigation includes the construction or improvement of a catchment area, its probable effectiveness must be considered. The rockfall retention guidance provided in this document is for a standalone catchment area mitigation measure. Commonly, a combination of mitigation measures may be applied. For example, if a barrier system is incorporated into the mitigation design, the full design criteria catchment area width may not be required. In such cases, the decision to reduce the catchment area width should be made by an experienced rock slope designer.

Through this research, design charts have been developed to evaluate catchment area effectiveness. Transportation agencies now have a quantitative tool with which to design catchment areas, based on a given design goal percentage of rockfall retention. They can use these tools to evaluate the economic feasibility of various cut slope and catchment area combinations that will maximize the benefit for a given investment.

The guidelines set forth in this report provide a means for designing catchment areas to varying percentage rockfall retention levels and for prioritizing of projects based on benefit/cost. As practitioners and state DOT policy officials consider the adoption of these guidelines, it is important to note that the application of such standards is not unique to design of rockfall catchment areas. Such an approach is analogous to numerous other programs administered by state and federal transportation agencies where program funding is limited. Examples include highway safety improvement projects; roadside hazard improvement projects; traffic safety improvement projects; bridge replacement projects; bridge seismic retrofit projects; and unstable slope correction projects. These programs are limited by available funding and involve prioritization and selection of projects based on use of ranking criteria, benefit/cost comparisons and professional judgment.

Legal counsel for both the Oregon DOT and Caltrans have advised that judges, juries and the public understand that due to limited funds and resources, public transportation agencies cannot be expected to correct every problem or deficiency immediately and cannot always design to 100% hazard reduction standards. They further advised that designing to less than 100% rockfall retention is legally defensible, when set as agency policy and done as part of a rational slope/rockfall assessment. Such catchment area design must be performed by experienced rock slope personnel using current state of the practice standards and within the economic constraints at the time of execution.

4.2 CATCHMENT AREA PERCENT RETENTION GRAPHS

Rockfall catchment area percent retention graphs have been prepared for vertical, 0.25H:1V, 0.5H:1V, 0.75H:1V, and 1.0H:1V cut slopes. The graphs are a compilation of the results from this latest research effort and the earlier 0.25H:1V slope pilot research project. The complete set of retention graphs is included in Appendix F. For each cut slope angle, the graphs show the rockfall impact and roll out retention widths compiled for all three slope heights, for all three catchment area configurations tested. The percent retention graphs were developed from the collected research data. Extrapolating beyond the graph limits – i.e., extending the curves below 40 feet or above 80 feet – is possible, but the decision to do so is left up to the discretion of the owner agency or the practitioner. Based on comparison of field test data to computer simulation results, computer simulation may be a viable method to evaluate the reasonableness of the values yielded from extended curves.

The percent retention graphs incorporate the maximum impact and roll out data points measured for the percentage indicated, converted from field measured slope distance to horizontal distance (4H:1V and 6H:1V foreslopes). In some cases, because of weather-related slope conditions, rockfall trajectory, or specific interaction with the catchment area, the maximum measurement shown on the retention graph may have occurred on any one of the three slope heights tested for each slope angle. In addition, this point may not be related to the larger rock size categories. Although the energy data indicated that the higher slopes and larger rocks tended to produce the highest rockfall energies, the higher energy rocks, depending on their trajectory, sometimes dissipated considerable energy by burrowing into the catchment area, reducing roll out distance.

The following sample percent retention graphs, included as Figures 4.1 and 4.2, are from the 0.75H:1V test slope. They represent 50% and 90% rockfall retention catchment area widths. Note that the horizontal scales are different. On the 50% chart for a 40-foot high slope the impact distance is zero. This means that at least 50% of the test rocks rolled into the catchment area at the toe of the slope, resulting in a zero value for impact distance.

On the 90% graph, the upper ends of the curves are becoming nearly vertical at the 80-foot slope height. This indicates that as slopes become higher, the need to continually increase the catchment area width diminishes. Although the curves do not extend below the 40-foot high slope value, for lower slopes where rockfall energies diminish, the trend of the impact and roll out curves will at some point reverse as they approach zero. At a minimum, the roll out values will be equal to the diameter of the rockfall.

Rockfalls can affect vehicles in three ways. They can impact a vehicle in trajectory, they can roll into a vehicle, or they can be in the way of a vehicle. The impact curves are included because they represent the minimum width needed to have the rockfalls land within the fallout area and not onto the roadway.

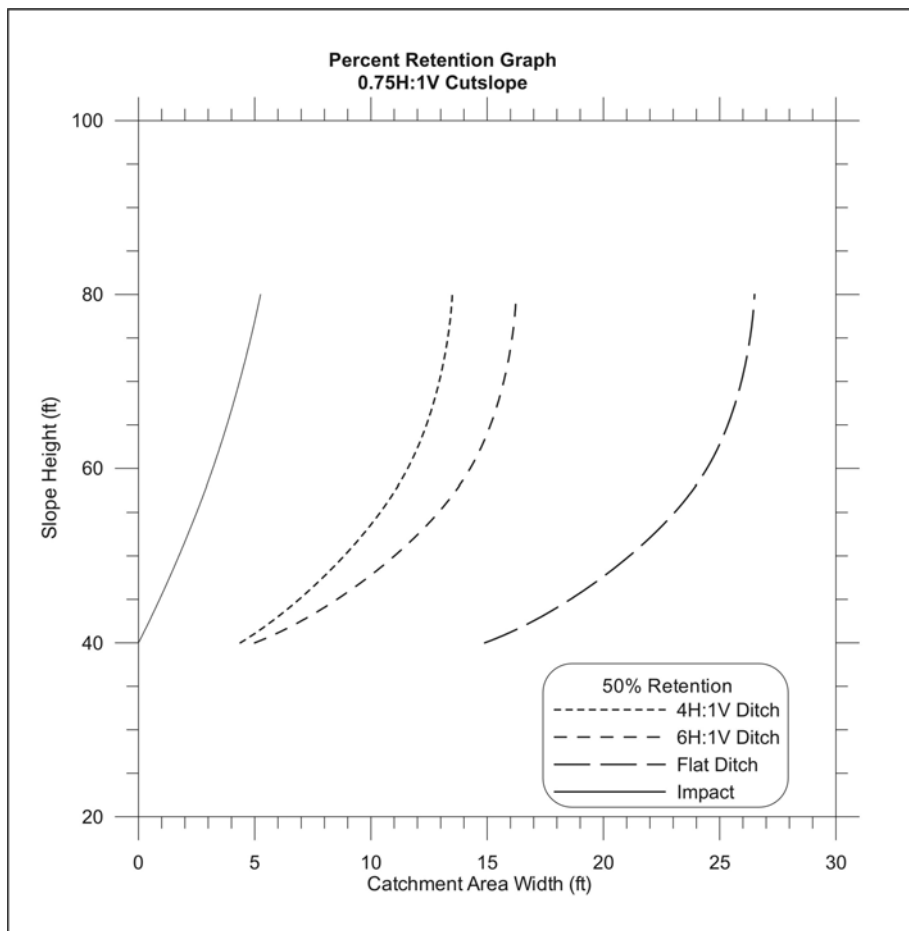

Figure 4.1: 50% Retention graph (0.75H:1V slope)

The complete suite of percent retention graphs, ranging from 30 to 99 percent retention, is included in Appendix F. If desired, the percent retention graphs can be used to design catchment area widths. The graphs allow easy interpolation of intermediate slope heights between the tested 40-, 60- and 80-foot heights.

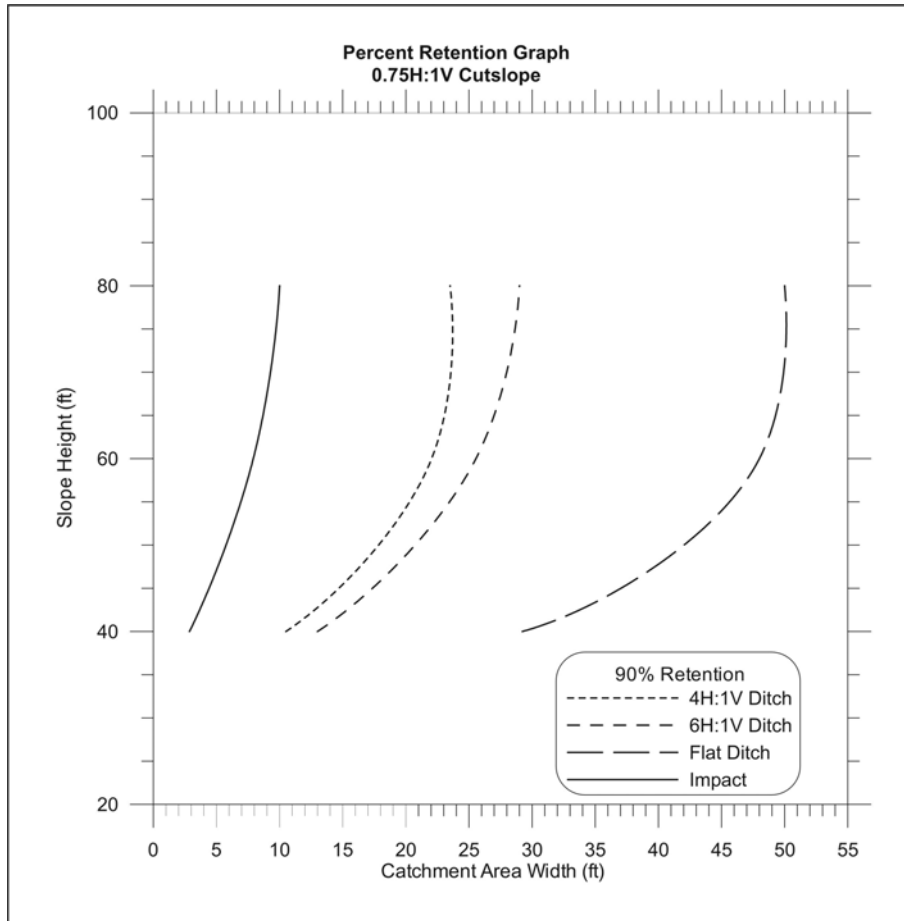

Figure 4.2: 90% Retention graph (0.75H:1V slope)

4.3 CUMULATIVE PERCENT RETAINED DESIGN CHARTS

Cumulative percent retained design charts have also been produced. These charts combine the data points from the percent retention graphs for a specific slope height. This is a “practitioner-friendly” format that allows rapid evaluation of catchment area widths as a comparison between the three catchment area slopes tested. They include all the percent retentions from 0 to 99%. Because the design charts have been created from a finite number of data points, the curves have been smoothed for practical use.

Figure 4.3 shows the cumulative percentage-retained curves for the 80-foot high, 0.25H:1V slope. The catchment area widths are plotted against the rockfall “cumulative percentages retained.” In this example, a horizontal line is shown that denotes the 90th percentile. This line intersects the impact curve at a catchment area width of 14 feet. This means that 90% of the rocks impacted (initially hit the ground) within a 14-foot wide zone adjacent to the toe of the cut slope.

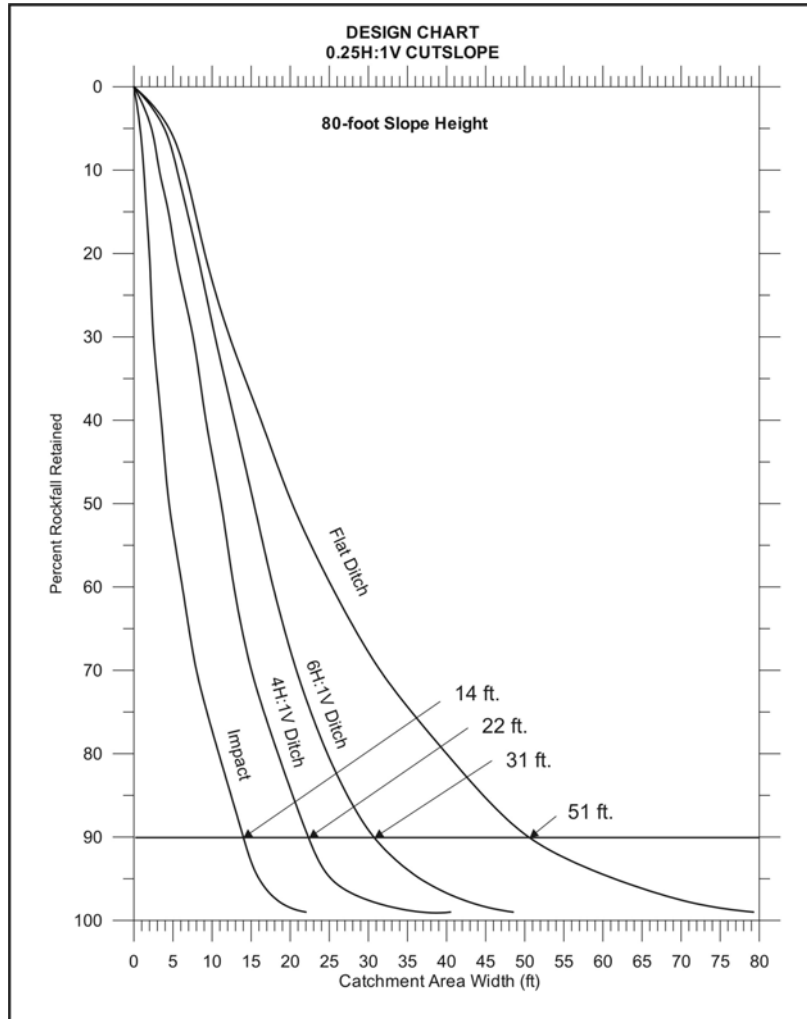

Figure 4.3: Cumulative percent retained for the 80-foot, 0.25H:1V slope

Following this 90th percentile line across, the intersection with the 4H:1V catchment area curve occurs at 22 feet; the intersection with the 6H:1V catchment area curve occurs at 31 feet; and the intersection with the flat bottom catchment area curve occurs at 51 feet – meaning 90% of all falling rocks had roll out distances less than or equal to these values. Using this approach, any combination of rockfall retained percentage and required catchment area width can be found for each of the catchment area configurations tested. The complete suite of design charts is presented in Chapter 5 (Figures 5.1 - 5.25).

4.4 STEP-BY-STEP DESIGN PROCEDURE

The following summarizes the step-by-step design procedure for dimensioning new rockfall catchment areas or evaluating existing catchment areas, using the developed design charts (Figures 5.1 - 5.25). Qualified, experienced rock slope engineering personnel should perform the overall rock slope design and catchment area dimensioning.

Step 1 - Establish overall design rock cut slope ratio based on overall rock slope stability.

Step 2 - Select critical rock cut slope design cross-section(s).

Step 3 - Select appropriate catchment area design chart, based on slope ratio and slope height.

Step 4 - When dimensioning new catchment areas, enter the appropriate slope design chart for a specified or desired percent rockfall retention and read off the required catchment area width, W , for the selected catchment area configuration(s), i.e., flat-bottom, 6H:1V or 4H:1V. This may need to be an iterative process, since wider catchment areas commonly result in higher rock cuts. It is also appropriate to perform a constructibility check to evaluate if the required catchment area width, W , will result in an overall rock excavation width sufficiently wide for excavation equipment to work the proposed cut slope to grade. Refer to Worked Example 1.

When evaluating the effectiveness of an existing catchment area, enter appropriate existing rock cut slope/catchment area slope design chart at existing catchment area width, W , and read off estimated percent rockfall retention. Refer to Worked Example 2.

Step 5 - When appropriate, perform benefit/cost comparison of alternate designs to select recommended final design. Refer to Worked Example 3.

The following worked examples illustrate the step-by-step design procedure and application of the design charts. See the Appendix G case study examples for more in-depth actual project application examples.

4.4.1 Worked Example 1 - Designing a New Catchment Area

Project Description: An existing section of highway in mountainous terrain is to be reconstructed as part of a safety improvement project. The project includes an approximate 1000-foot long rock slope consisting of basalt rock. The existing cut is 65-foot maximum height with slope ratio varying from near vertical to 0.3H:1V through the length of the cut. Natural ground slope behind the top of cut is approximately 2H:1V. The original construction was done in the 1950's when uncontrolled blasting was used, resulting in significant blast damage several feet into the slope, causing significant rockfall. Only a narrow 5-foot ditch width exists between the edge of pavement (EP) and base of rock slope. Two rockfall-caused accidents have occurred along the cut section during the past 5 years.

The design project manager has decided that construction of a rockfall catchment area is warranted. Agency policy on primary highways is to design catchment areas to provide 90% rockfall retention, whenever economically feasible.

Determine: Required catchment area width, W, to provide 90% rockfall retention.

Step 1 - Establish overall design rock cut slope ratio based on overall rock slope stability.

Agency geotechnical personnel recommend a design slope ratio of 0.25H:1V for overall slope stability. Agency policy is to use controlled blasting to improve overall stability and to minimize long-term rockfall.

Step 2 - Select critical rock cut slope design cross-section(s).

Plotting the 0.25H:1V slope on the roadway design cross-section, and assuming a cut widening in the 20-30 foot range to provide rockfall catchment, gives a maximum new cut slope height of approximately 80 feet.

Step 3 - Select the appropriate catchment area design chart based on slope ratio and slope height.

The Design Chart for 0.25H:1V Cut Slope, 80-foot Slope Height is selected. See Figure 4.4.

Step 4 - When dimensioning new catchment areas, enter appropriate slope design chart for a specified or desired percent rockfall retention and read off the required catchment area width, W, for desired catchment area slope(s), i.e., flat-bottom, 6H:1V or 4H:1V.

Entering the Figure 4.4 design chart at 90% rockfall retained and reading across to the various catchment area slope curves gives the following required catchment area widths, W:

Catchment Area Slope	Required Width W
Flat	51 feet
6H:1V	31 feet
4H:1V	22 feet

Agency policy is to use a 6H:1V sloped clear zone slope whenever possible. This gives a required catchment area width of 31 feet.

Perform the constructibility check. The Agency's controlled blasting specifications limit drilling lift heights to 40 feet. The 80-foot high cut excavation will require two excavation lifts. Examination of all cross-sections through the length of proposed cut shows that the 31-foot excavation width is wide enough to accommodate construction drilling and excavation equipment working the cut. Constructibility OK.

Design Recommendation: A rockfall catchment area width of 31 feet with 6H:1V bottom slope is recommended for final design.

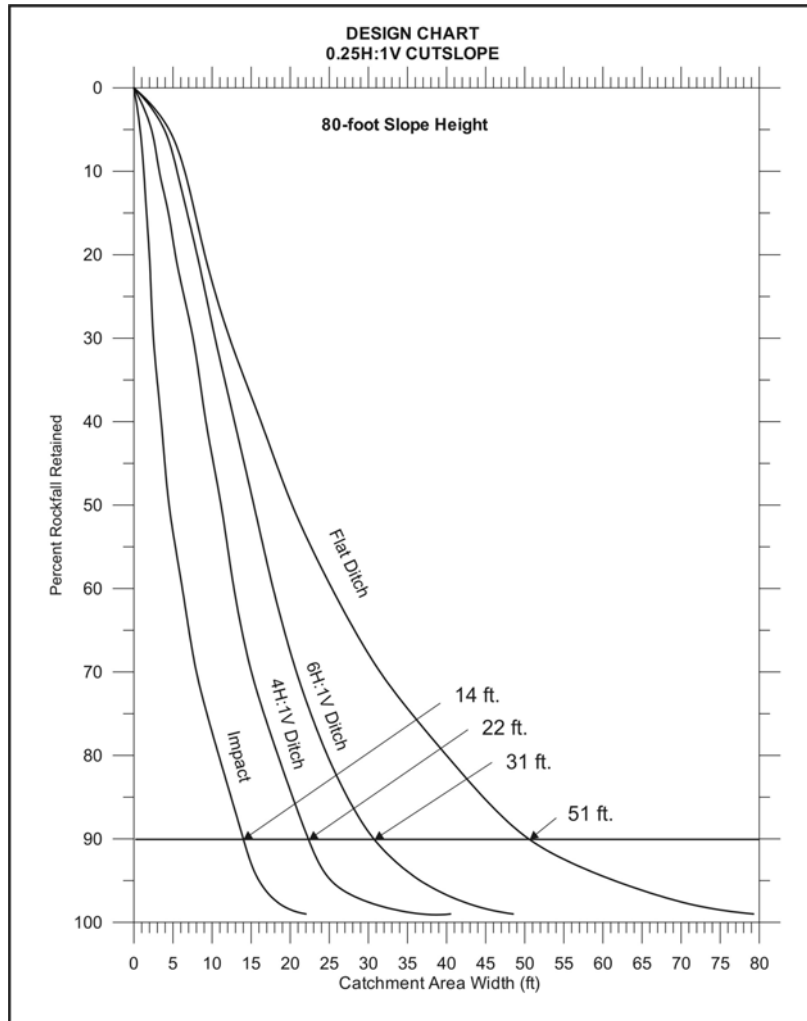

Figure 4.4: Design chart for 80-foot high, 0.25H:1V slope (Example 1)

4.4.2 Worked Example 2 - Evaluating an Existing Catchment Area

Using the cumulative percent retained design charts, the practitioner can also quickly evaluate the effectiveness of existing catchment areas adjacent to rock slopes. This is demonstrated in the following example.

Project Description: An 80-foot high, 500-foot long highway cut has a rockfall problem. The slope ratio is 0.25H:1V. A site visit reveals that a small portion of the cut length possesses the greatest hazard. Rockfalls appear to be generated primarily from the upper half of the cut. The existing catchment area width is constant at 25 feet, and most catchment area sections slope toward the toe of slope at approximately 4H:1V. However, the catchment area slope changes to 6H:1V or flatter in the problem area.

Determine: Estimate the percent rockfall retention provided by the existing catchment area and the most cost-effective way to increase the catchment area effectiveness.

Finding a catchment area width of 25 feet in the Figure 4.5 design chart. Following it up to the 6H:1V curve indicates that only 80% of the rocks falling into this section of the catchment area can be expected to be retained. Approximately 20% of rocks are allowed to reach the roadway. Alternately, 95% of rockfalls are retained in a catchment area of the same width with a 4H:1V catchment area slope, an increase in catchment of 15%.

Design Recommendation: Recommending a simple re-grading of the catchment area slope from the existing 6H:1V to 4H:1V significantly increases catchment area effectiveness and enhances public safety for a relatively small investment.

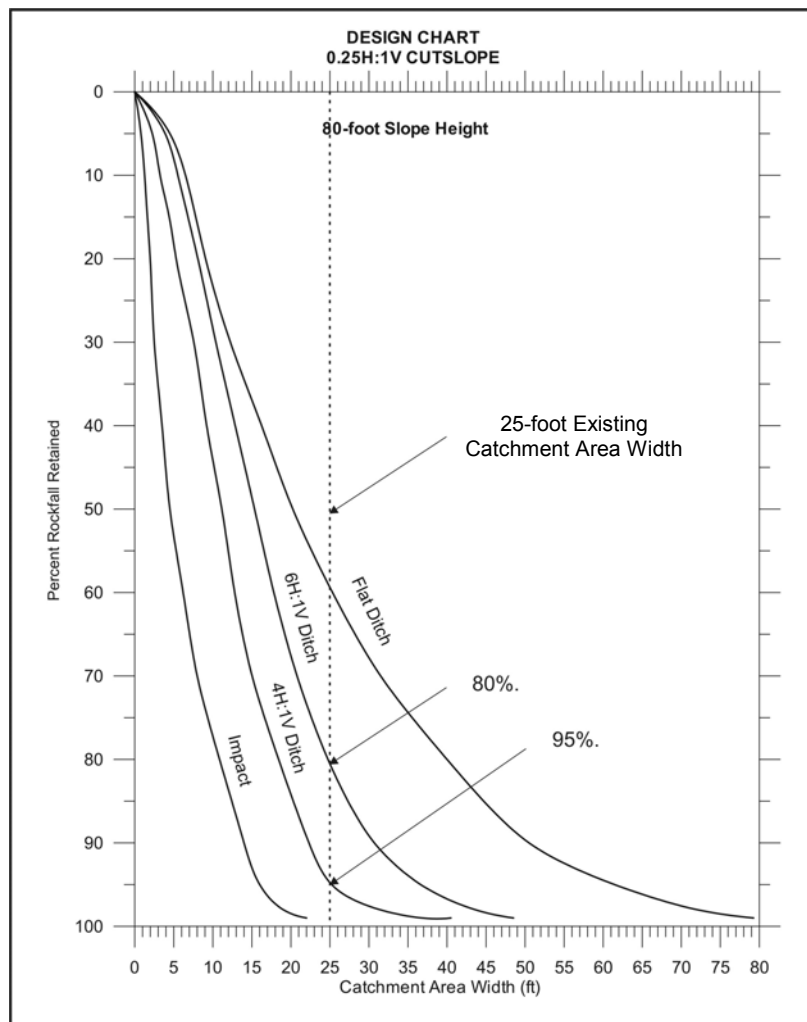

Figure 4.5: Design chart for 80-foot high, 0.25H:1V slope (Example 2)

Using the research data in this manner demonstrates a method for evaluating existing slopes. In a real highway cut, rocks could begin their fall from anywhere on the slope. Rockfalls may only initiate from one or two zones or from random locations scattered throughout the slope. In addition, catchment area geometry may vary appreciably throughout a cut section. Because of this, a higher or lower percentage of rocks may be retained than the design charts estimate. Obviously, an application of this sort requires the user to make a qualitative assessment of the slope. Site-specific characteristics must be considered if a realistic evaluation of catchment area effectiveness is to be obtained. Experienced rock slope engineering personnel should make these assessments.

4.4.3 Worked Example 3 - Benefit/Cost Comparison

On a national and international level, the problem of rockfall is significant, particularly in mountainous states/countries. Rockfall problems are typically dealt with using either a strategy of elimination or reduction. The goal of 100 % (zero tolerance) rockfall hazard elimination, while desirable, is difficult to attain. A limited budget, as well as a desire to limit the effects of highway construction on adjacent properties and the environment, usually precludes directing sufficient resources toward the total 100% elimination of a rockfall problem.

A more practical approach is to reduce the potential for rock on the road along as many miles of roadway as possible using the budget available. Hazard reduction along many miles of roadway provides a more consistent benefit than if only a short section of a given roadway had its entire rockfall problem eliminated for the same cost.

An informed decision must be made regarding hazard reduction relative to cost. The following generic example illustrates such a benefit/cost approach.

Project Description: Rockfall on the highway has been a serious problem along the high side of a 400-foot long through cut for many years. A design cross section of the site is shown in Figure 4.6. No catchment area was provided during the original construction. The agency would like to reduce the rockfall hazard but is unsure what level of improvement can be obtained for a reasonable investment.

Determine: Perform a benefit/cost comparison of alternate catchment area widths.

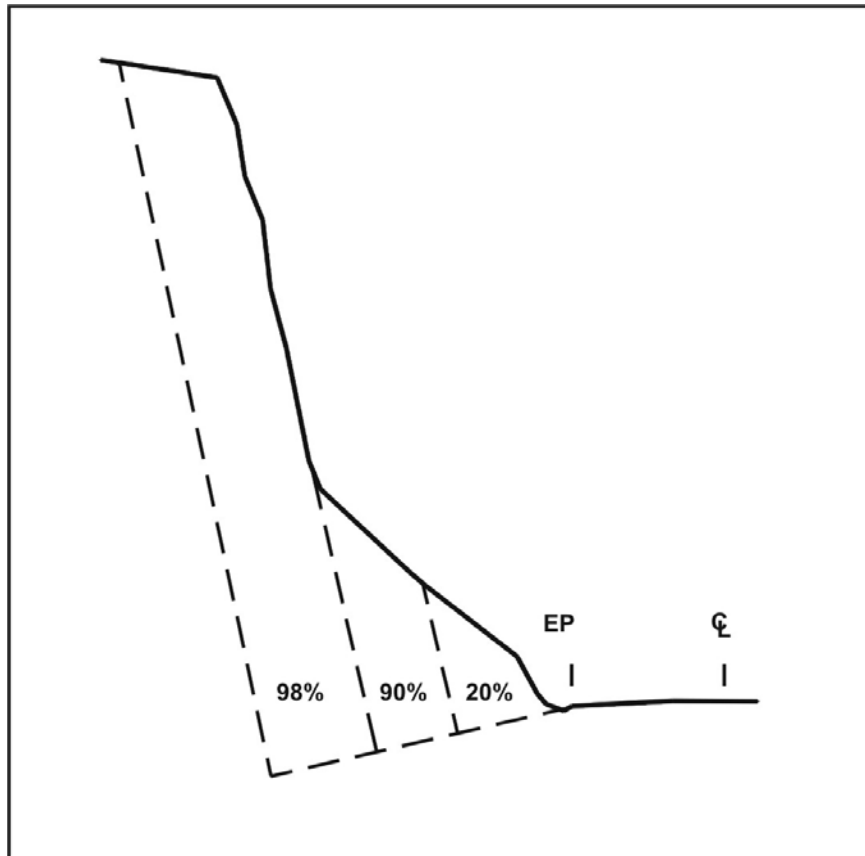

Figure 4.6: Slope cross-sections; benefit/cost comparison (Example 3)

Rockfall is possible from anywhere on the slope. Because of the shape of the slope (see Figure 4.6), excavation quantities will increase in a non-linear fashion as the catchment area width is increased. Therefore, the cost of a small amount of increased width is low initially, since the cut height would be low. As excavation of the entire slope is approached, the cost of each increment of catchment area width becomes higher due to the increasing cut height. For this example, the catchment area widths associated with providing 20%, 90% and 98 % rockfall retention are shown on Figure 4.6.

The results of this benefit/cost analysis can also be illustrated graphically as shown on Figure 4.7. Different excavation costs based on catchment area width are plotted against the percentage of rock that will be retained for a specific slope height and catchment area width. Using this method enables different options to be discussed in the decision making process. Both the benefits and costs can be clearly shown, and a prudent decision on the allocation of funds can be made. In this example, the cost of improvement between 20% and 90% rockfall retention is about the same as it is between 90% and 98%, i.e., increasing the percent retention the additional 8% from 90% to 98% nearly doubles the construction cost. Further, the additional catchment area width required to provide the additional 8% retention from 90% to 98% approximately triples the cut height, causing a far more severe impact to adjacent properties and the environment.

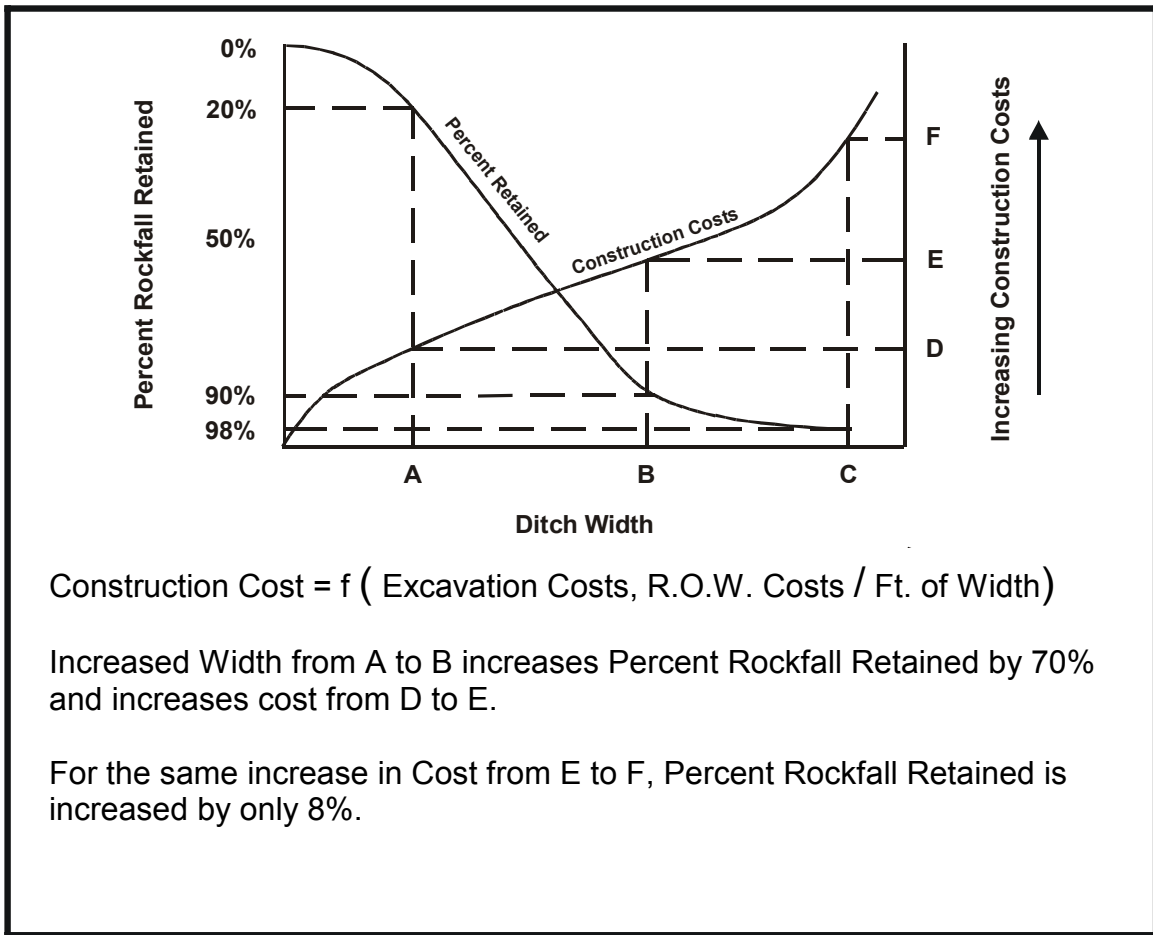

Figure 4.7: Example benefit/cost comparison (Example 3)

Design Recommendation: Based on this benefit/cost comparison, a catchment area width that provides 90% rockfall containment is selected.

4.4.4 Project Case Study Application Examples

Seven actual project case study examples are provided to further illustrate the practical application and ease of use of the rockfall catchment area design charts to dimension rockfall catchment areas. Several of the participating state and FHWA Technical Advisory Committee members provided case studies of actual projects where the new design criteria and design charts have been used, or where site specific rockfall testing was conducted to aid in the rockfall mitigation design. The case studies also illustrate the type of benefit/cost comparisons and experienced geotechnical judgment applied to arrive at final design recommendations.

Arizona, California, Federal Highway Administration - Central Federal Lands Highway

Division (FHWA-CFLHD), New York, Oregon, Washington, and Wyoming submitted project case study examples. These are included in Appendix G in their entirety.

The **Arizona** project involves highway widening of a portion of US 191 near the town of Morenci, AZ. Existing cutslopes generate substantial rockfall onto the road during rainstorms. Interesting features of this project include the use of actual rock rolling from one of the cutslopes during construction, combined with computer simulation using CRSP, to determine the extent of draped slope mesh required. This was necessitated by a roadway design decision to reduce the rockfall catchment area width and depth below that called for by the Ritchie criteria. ADOT also provides a comparison to the new design charts presented in this design guide.

The **California** project involves a curve correction along State Route 101 near the Monterey and San Benito county line by Caltrans District 5. The California project illustrates benefits of the new design charts to estimate percent rockfall retention and use of a flatter slope catchment versus a very deep Ritchie ditch.

The **New York** (Corning Bypass) project involves highway widening on State Route 17. This project utilized site specific rock rolling, combined with computer simulation, to determine the required height of a rockfall catchment fence, when roadway design changes reduced the available rockfall catchment area width.

The **Oregon** project is a cut widening being done as part of a roadway alignment improvement project on US 26 in the Mt. Hood National Forest.

The **FHWA-CFLHD** project includes a cut widening for a realignment of New Mexico Forest Highway, Route 45 near Sunspot, New Mexico.

The Oregon and FHWA-CFLHD examples are projects where the rockfall catchment areas had already been designed prior to the new design charts becoming available. These case studies illustrate “after the fact” catchment area width and cost comparisons of the as-designed catchment area widths, based on the Ritchie criteria, to the widths given by the new design charts.

The **Washington** project involves highway widening on a project on SR-243 in eastern Washington. The Washington case study compares use of the new design charts to current WSDOT rockfall ditch criteria (modified after Ritchie) for dimensioning new rockfall catchment areas and illustrates benefits of the new design charts. The Washington case study also illustrates the importance and benefit of paying attention to constructibility considerations as part of design.

The **Wyoming** project illustrates use of the new design charts to dimension a new rockfall catchment area constructed as part of a highway-widening project on US 26-89 in the Snake River Canyon.

Special thanks to Bill Hurguy and John Lawson (Arizona DOT), John Duffy (Caltrans), Barry Siel and Sam Holder (FHWA-CFLHD), Alex Yatsevitch (New York DOT) and Mike Vierling (New York Thruway Authority), Don Turner (Oregon DOT), Steve Lowell (Washington State DOT), and Mark Falk (Wyoming DOT) for their extra time and effort preparing these case study submittals.

5.0 COMPLETE SUITE OF DESIGN CHARTS

The Rockfall Catchment Area Design Guide is a current state of the practice reference for sizing rockfall catchment areas for 40- to 80-foot high rock cut slopes.

With the newly developed design charts, practitioners can more quickly and easily dimension new rockfall catchment areas or evaluate the effectiveness of existing catchment areas for rock cut slopes in the 40- to 80-foot height range. Practitioners will also be able to design and construct catchment areas that will have a predictable rockfall retention capacity.

5.1 USE OF DESIGN CHARTS

The Cumulative Percent Rockfall Retained Design Charts are included here for the vertical, 0.25H:1V, 0.5H:1V, 0.75H:1V, and 1.0H:1V cut slopes (Figures 5.1 - 5.25). These charts are derived from the data in the percent retention graphs for a specific slope height. The design charts are presented in a handy format that allows rapid evaluation of catchment area widths as a comparison between the three catchment area slopes tested.

To facilitate practical design usage, the field measured catchment area impact and roll out slope distances have been converted to horizontal catchment area width on the design charts.

The design charts are presented in a form that can be used to rapidly size rockfall catchment areas that satisfy specific rock catching/retention requirements. Based on slope angle, slope height and catchment area slope, the design charts estimate the required catchment area widths that will retain percentages of rockfall, ranging from 0 to 99 percent.

As a further design aid, the design charts include a handy “Quick Reference” table, listing the rockfall catchment width, W, required to provide 50%, 75%, 80%, 85%, 90%, 95% and 99% rockfall retention.

While the design charts have been developed for standard slope ratios (i.e., vertical, 0.25H:1V, 0.5H:1V, 0.75H:1V, 1H:1V) for practical design use, non-geotechnical users are cautioned that this should not be taken to imply that rock slopes are always designed to these standard slope ratios. Proper rock slope design requires designing the slope ratio (or angle) based upon the orientation of the predominant structural discontinuities that will control the slope’s overall stability. In many instances, this will be a slope ratio (or angle) different from those represented on the design charts. When this occurs, interpolation between charts can be used to determine the required catchment width. To facilitate this, the following table of slope ratio/slope angle equivalents is provided for easy reference:

Table 5.1: Slope ratio/slope angle equivalents

Decimal Slope Ratio	Fraction Slope Ratio	Slope Angle (Degrees)
Vertical	Vertical	90
0.25H:1V	¼ to 1	76
0.5H:1V	½ to 1	63
0.75H:1V	¾ to 1	53
1H:1V	1 to 1	45

5.2 DESIGN CHART LIMITATIONS

It is important to note that the design charts developed by this research effort are considered to be conservative. In general, the rock type at the Krueger Quarry test site is hard durable basalt that rebounds well after impact and rolls well. Slopes comprised of softer rocks would tend to have lesser impact and roll out distances. In addition, all the rocks started at the top of the slope for each slope height tested. In reality, rocks can and do fall from all portions of a slope. The result is that rocks that initiate from heights less than the maximum possible may not require the entire catchment area width to achieve the specified containment.

Although this was an extensive research effort, it should be kept in mind that different weather, slope and catchment area conditions, rock qualities and rockfall generation sources that vary significantly from those present at the research site may result in different behavior. **It is important to have experienced rock slope engineering personnel (engineering geologists/geotechnical engineers) involved in designing rock slope catchment areas. They should evaluate and decide when it is appropriate to directly use the figures in the enclosed design charts or to modify the catchment area dimensions shown.**

Because there are many different combinations of slopes, catchment areas, rock types and maintenance practices, it is possible for rockfall to occur where the result exceeds the maximum-recorded value documented in this report. With any data set, outliers are possible. For that reason, the highest retention design chart represents 99% retention, not 100%.

In a real highway cut, rocks could begin their fall from anywhere on the slope. Rockfalls may initiate from one or two zones or from random locations scattered throughout the slope. In addition, catchment area geometry may vary appreciably throughout a cut section. Because of these factors, a higher or lower percentage of rocks may be retained than the design charts estimate. Obviously, an application of this sort requires the user to make a qualitative assessment of the slope. Site-specific characteristics must be considered if a realistic evaluation of catchment area effectiveness is to be obtained. **Experienced rock slope engineering personnel should make these assessments.**

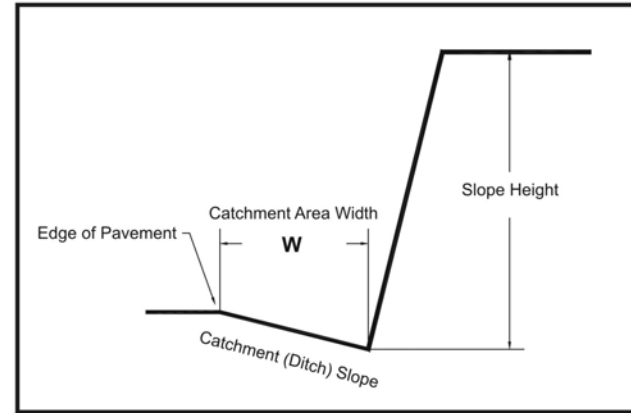
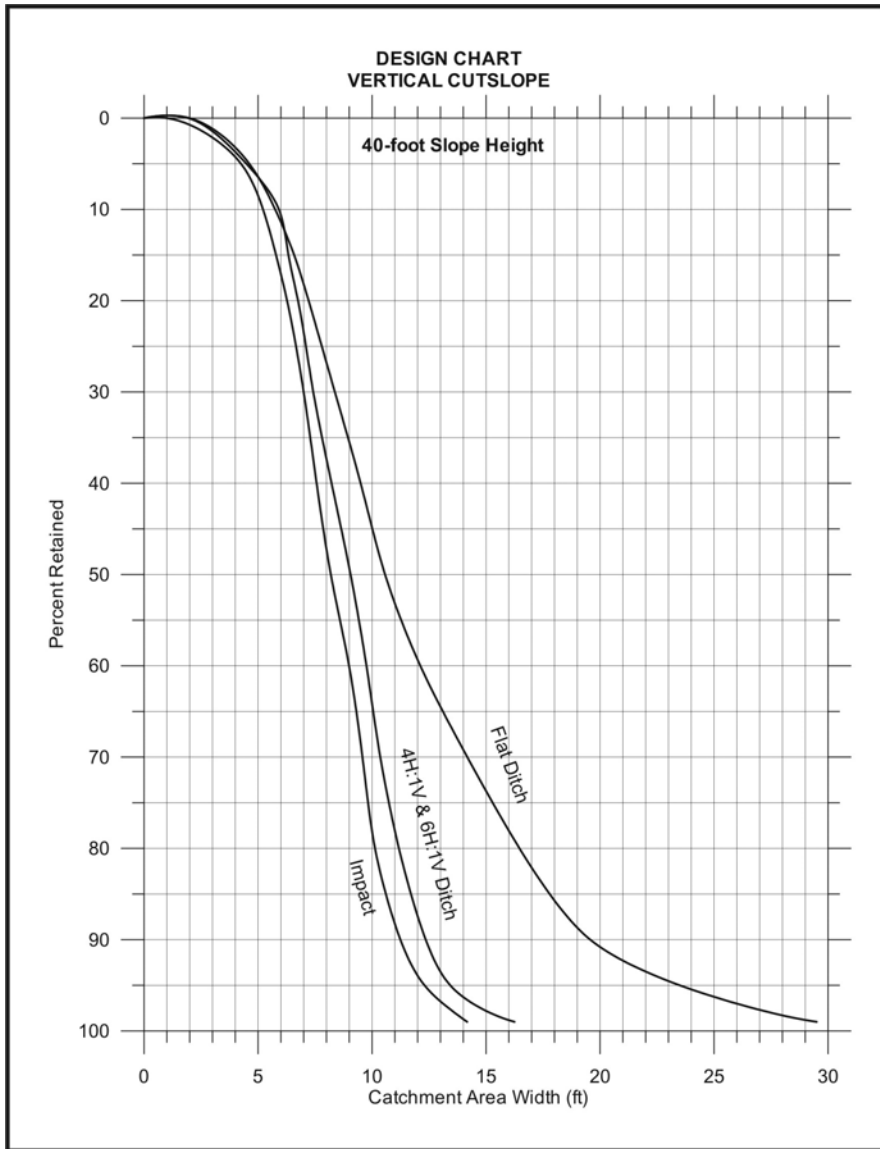

**Quick Reference - 40-Ft Slope
Catchment Area Width - **W****

Percent Rockfall Retained	Impact W (ft)	Catchment Area Slope		
		4H:1V W (ft)	6H:1V W (ft)	Flat W (ft)
50%	8	9	9	11
75%	10	11	11	15
80%	10	11	11	16
85%	11	12	12	18
90%	11	12	12	20
95%	12	13	13	24
99%	14	16	16	30

Figure 5.1: Design chart for 40-foot high vertical cut slopes

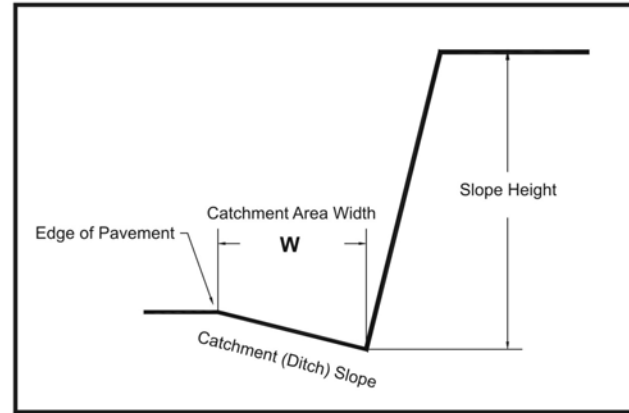
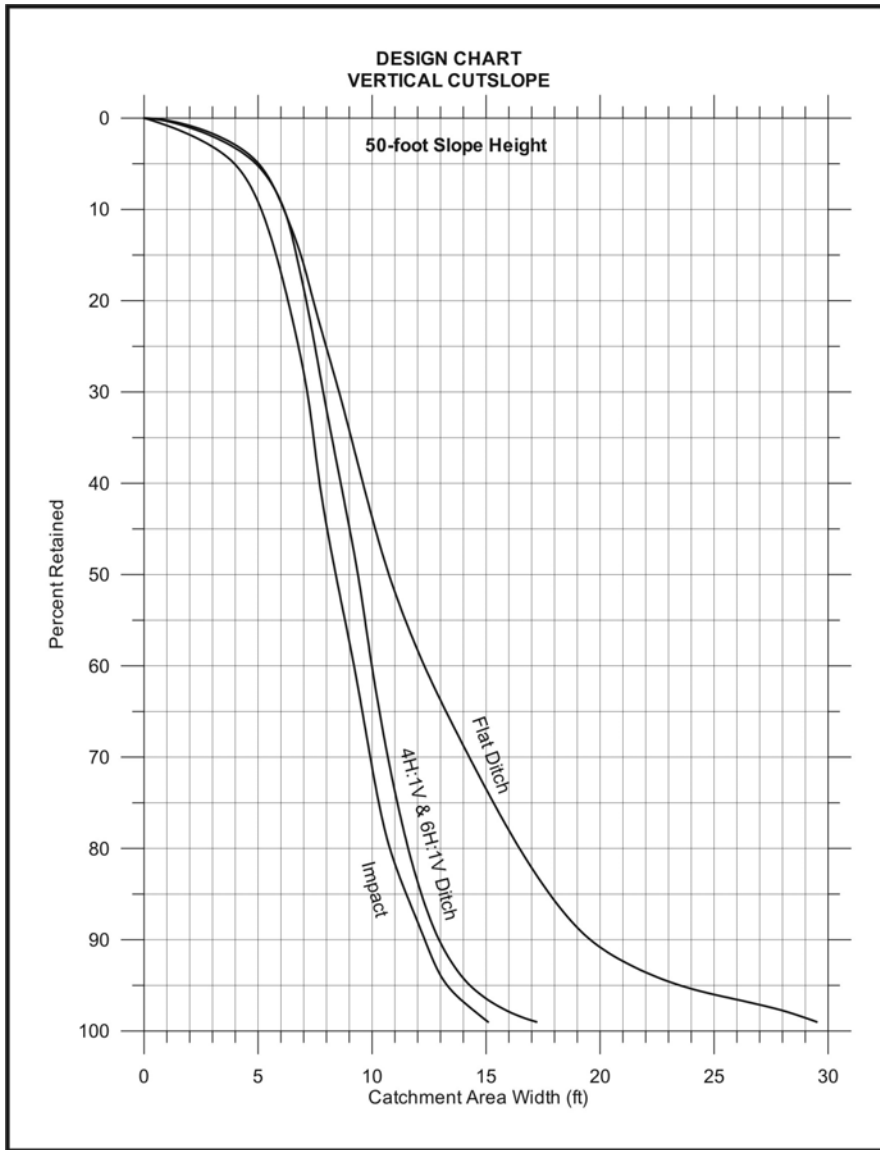

**Quick Reference - 50-Ft Slope
Catchment Area Width - **W****

Percent Rockfall Retained	Impact W (ft)	Catchment Area Slope		
		4H:1V W (ft)	6H:1V W (ft)	Flat W (ft)
50%	8	9	9	11
75%	10	11	11	15
80%	11	12	12	16
85%	11	12	12	18
90%	12	13	13	20
95%	13	14	14	24
99%	15	17	17	30

Figure 5.2: Design chart for 50-foot high vertical cutslopes

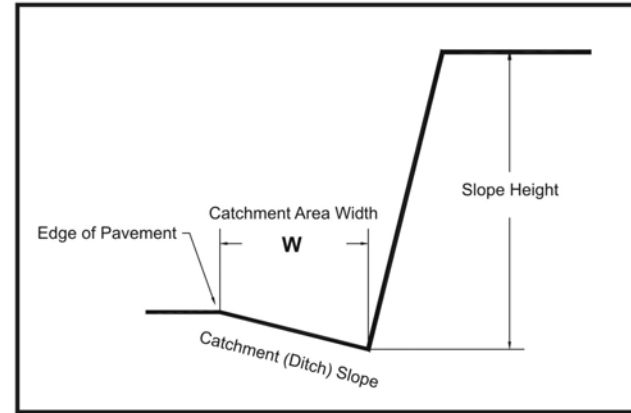
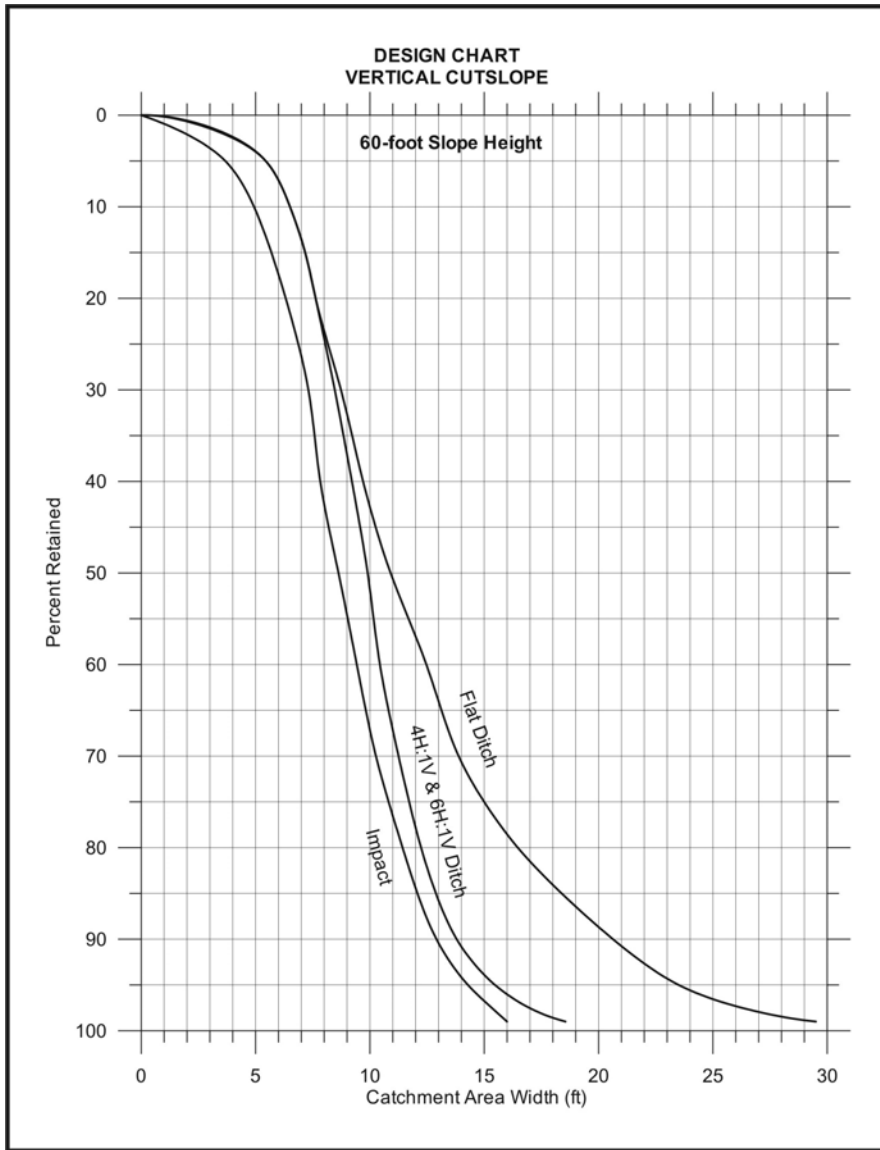

Quick Reference - 60-Ft Slope
Catchment Area Width - **W**

Percent Rockfall Retained	Impact W (ft)	Catchment Area Slope		
		4H:1V W (ft)	6H:1V W (ft)	Flat W (ft)
50%	9	10	10	11
75%	11	12	12	15
80%	11	12	12	16
85%	12	13	13	18
90%	13	14	14	21
95%	14	15	15	24
99%	16	19	19	30

Figure 5.3: Design chart for 60-foot high vertical cutslopes

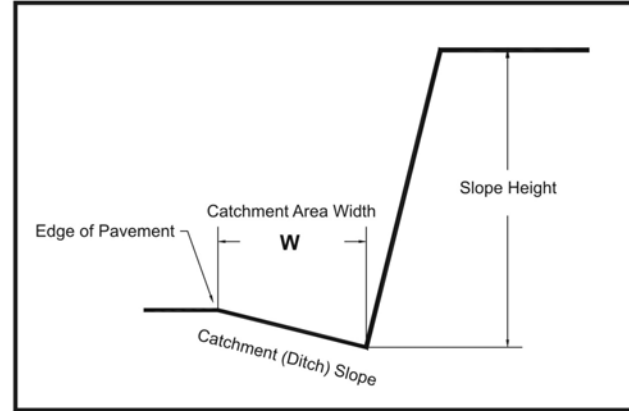
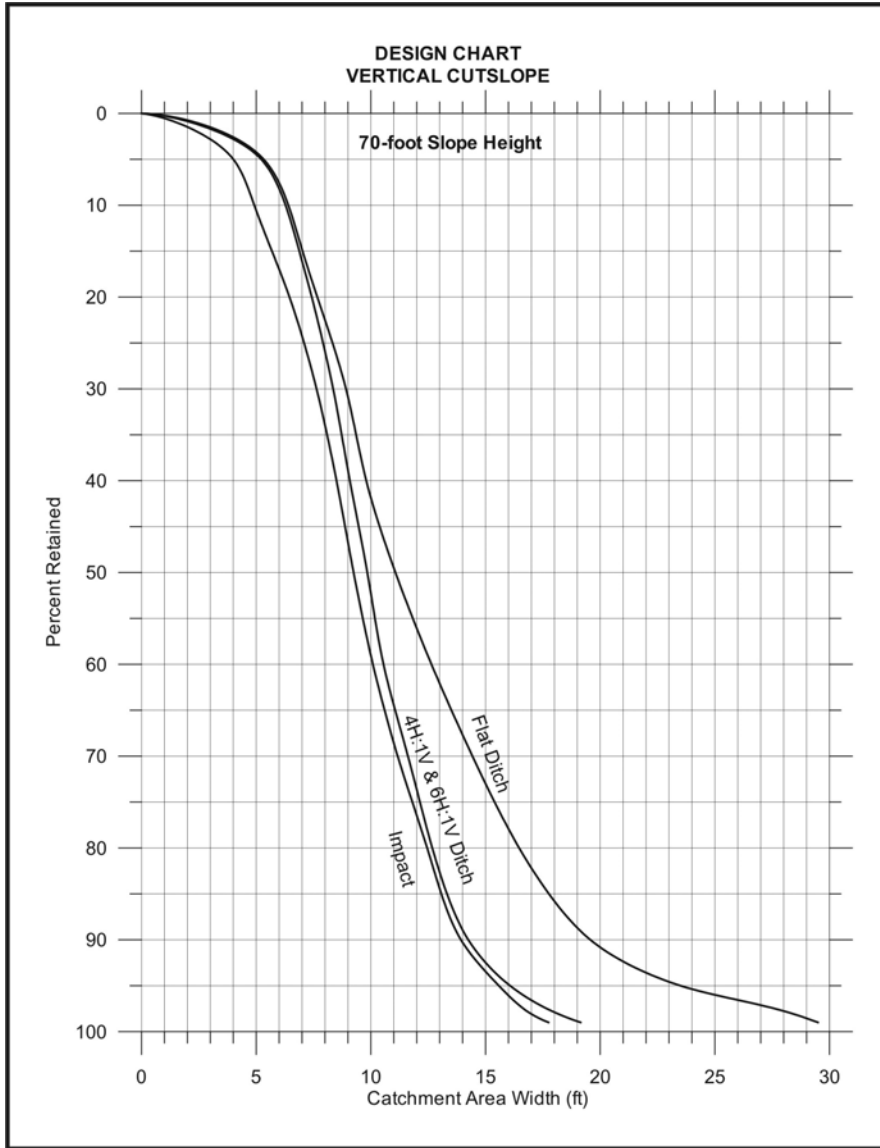

Quick Reference - 70-Ft Slope
Catchment Area Width - **W**

Percent Rockfall Retained	Impact W (ft)	Catchment Area Slope		
		4H:1V W (ft)	6H:1V W (ft)	Flat W (ft)
50%	9	10	10	11
75%	12	12	12	15
80%	12	13	13	16
85%	13	13	13	18
90%	14	14	14	20
95%	16	16	16	24
99%	18	19	19	30

Figure 5.4: Design chart for 70-foot high vertical cutslopes

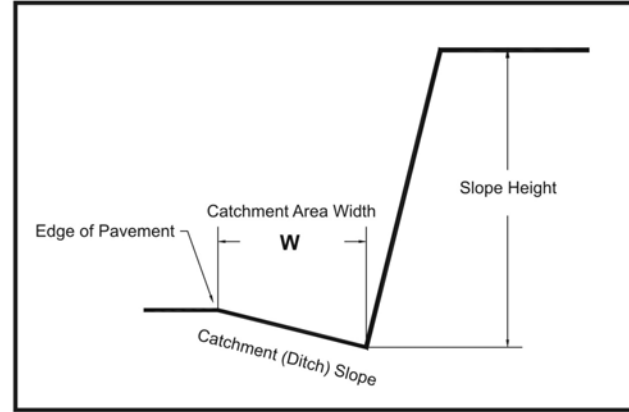
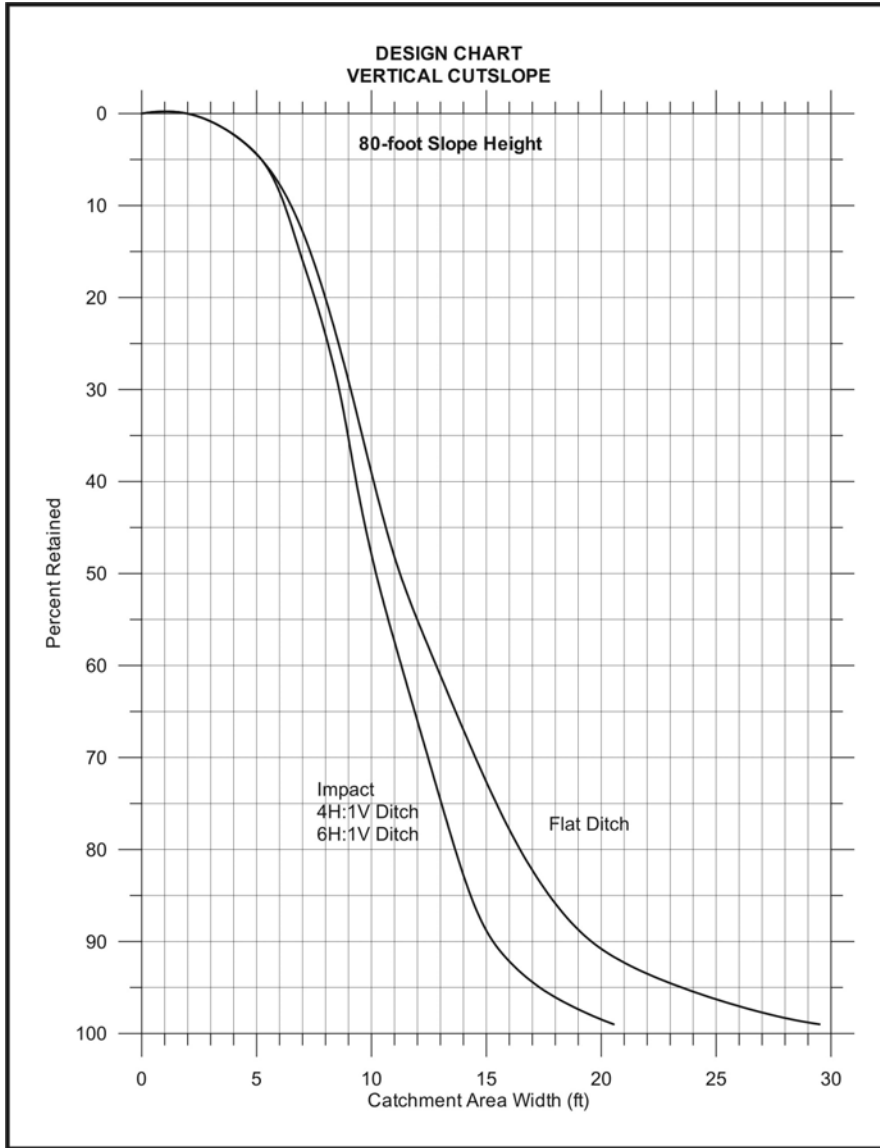

**Quick Reference - 80-Ft Slope
Catchment Area Width - **W****

Percent Rockfall Retained	Impact W (ft)	Catchment Area Slope		
		4H:1V W (ft)	6H:1V W (ft)	Flat W (ft)
50%	10	10	10	11
75%	13	13	13	15
80%	14	14	14	16
85%	14	14	14	18
90%	15	15	15	20
95%	17	17	17	24
99%	21	21	21	30

Figure 5.5: Design chart for 80-foot high vertical cutslopes

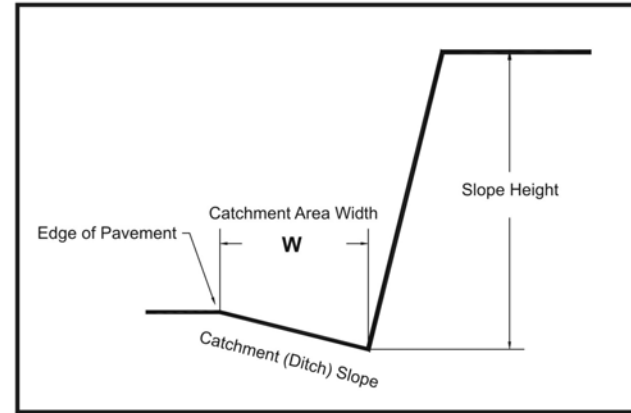
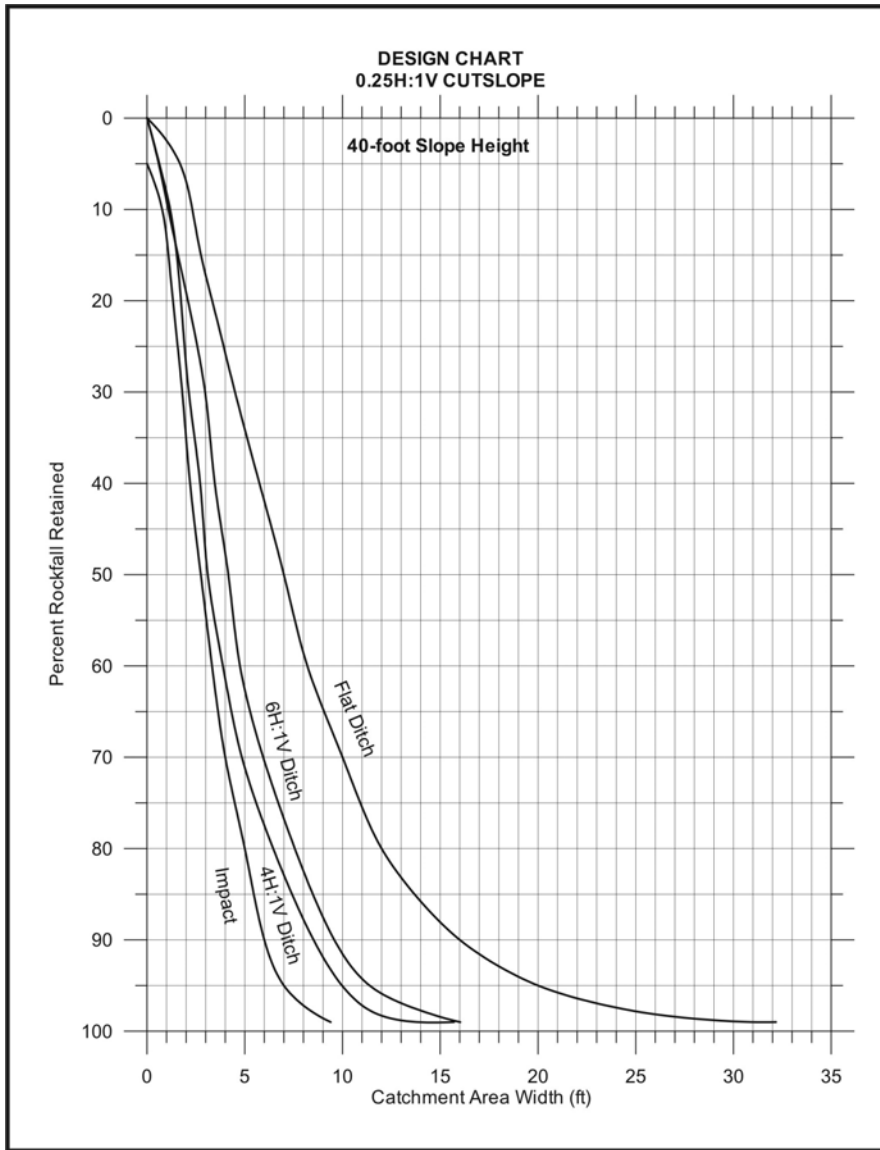

**Quick Reference - 40-Ft Slope
Catchment Area Width - **W****

Percent Rockfall Retained	Impact W (ft)	Catchment Area Slope		
		4H:1V W (ft)	6H:1V W (ft)	Flat W (ft)
50%	3	3	4	7
75%	4	6	7	11
80%	5	6	8	12
85%	5	7	8	14
90%	6	9	10	16
95%	7	10	11	20
99%	9	16	16	32

Figure 5.6: Design chart for 40-foot high 0.25H:1V cutslopes

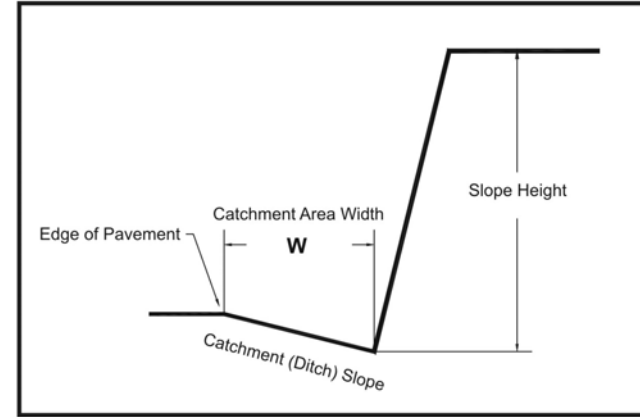
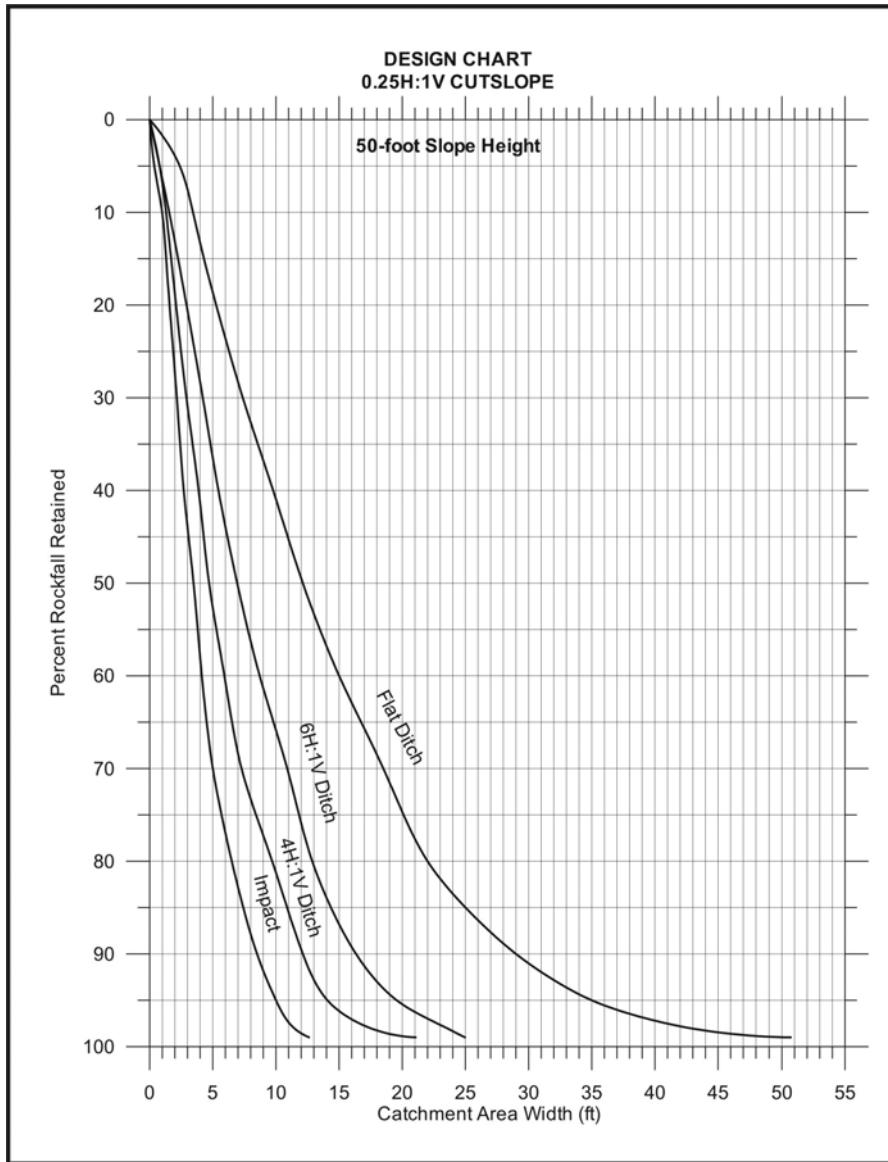

**Quick Reference - 50-Ft Slope
Catchment Area Width - **W****

Percent Rockfall Retained	Impact W (ft)	Catchment Area Slope		
		4H:1V W (ft)	6H:1V W (ft)	Flat W (ft)
50%	3	5	7	12
75%	6	8	12	20
80%	7	10	13	22
85%	7	11	14	25
90%	8	12	16	29
95%	10	14	19	35
99%	13	21	25	51

Figure 5.7: Design chart for 50-foot high 0.25H:1V cutslopes

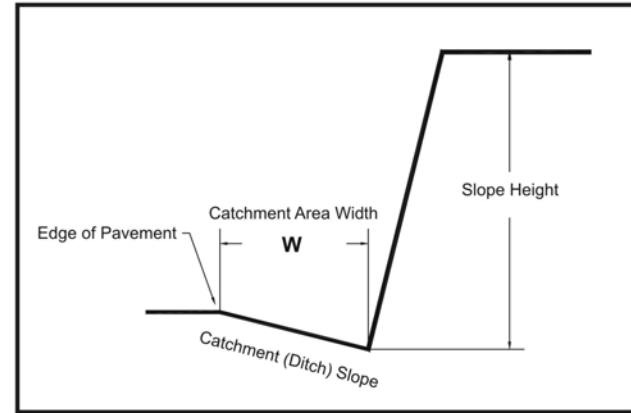
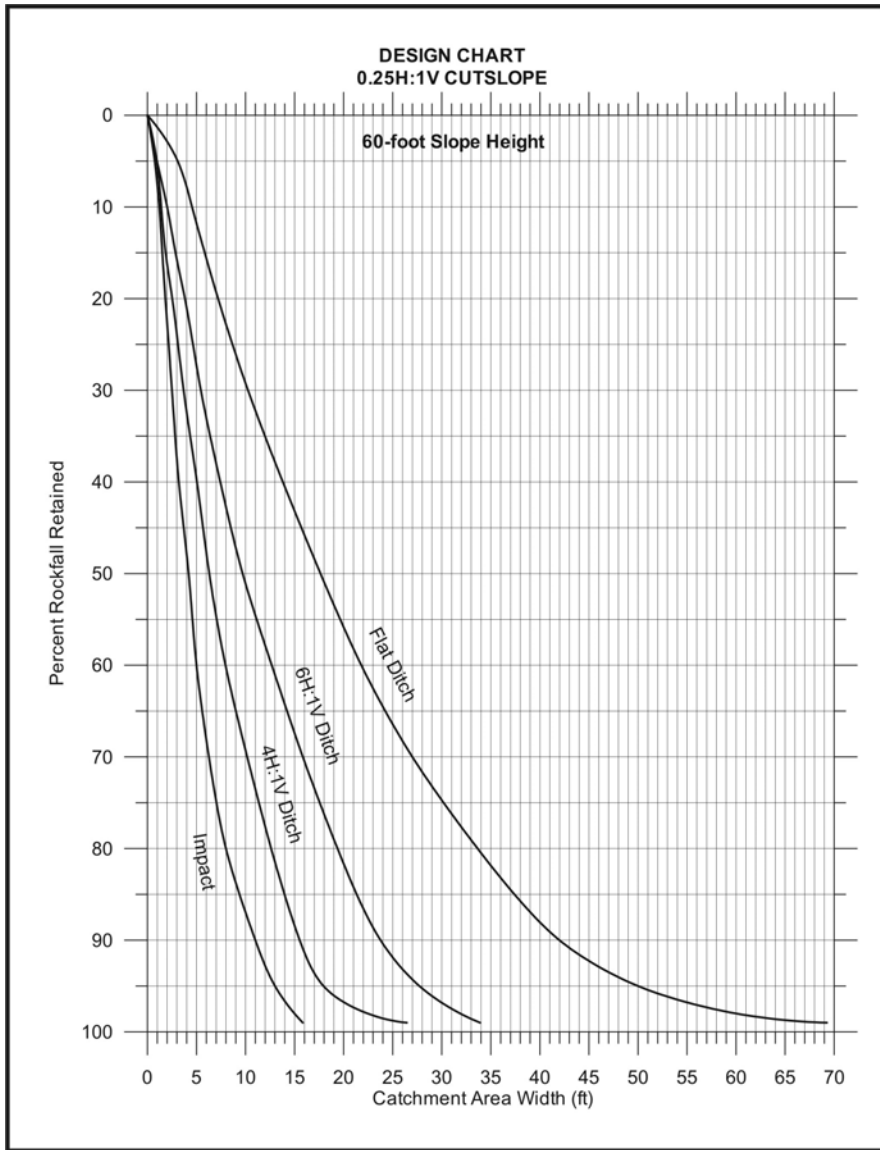

**Quick Reference - 60-Ft Slope
Catchment Area Width - **W****

Percent Rockfall Retained	Impact W (ft)	Catchment Area Slope		
		4H:1V W (ft)	6H:1V W (ft)	Flat W (ft)
50%	4	6	10	18
75%	7	11	18	30
80%	8	13	19	34
85%	9	14	21	37
90%	11	16	24	42
95%	13	18	28	50
99%	16	26	34	69

Figure 5.8: Design chart for 60-foot high 0.25H:1V cutslopes

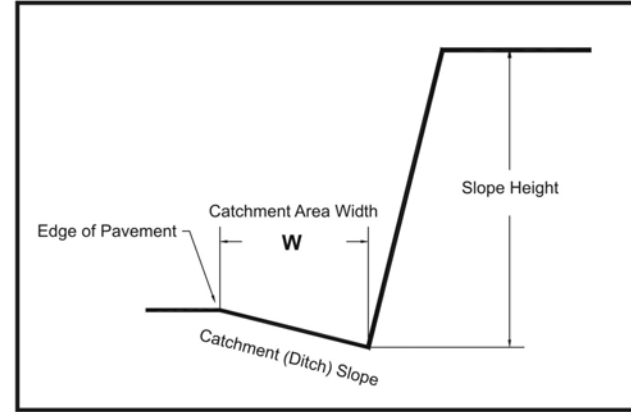
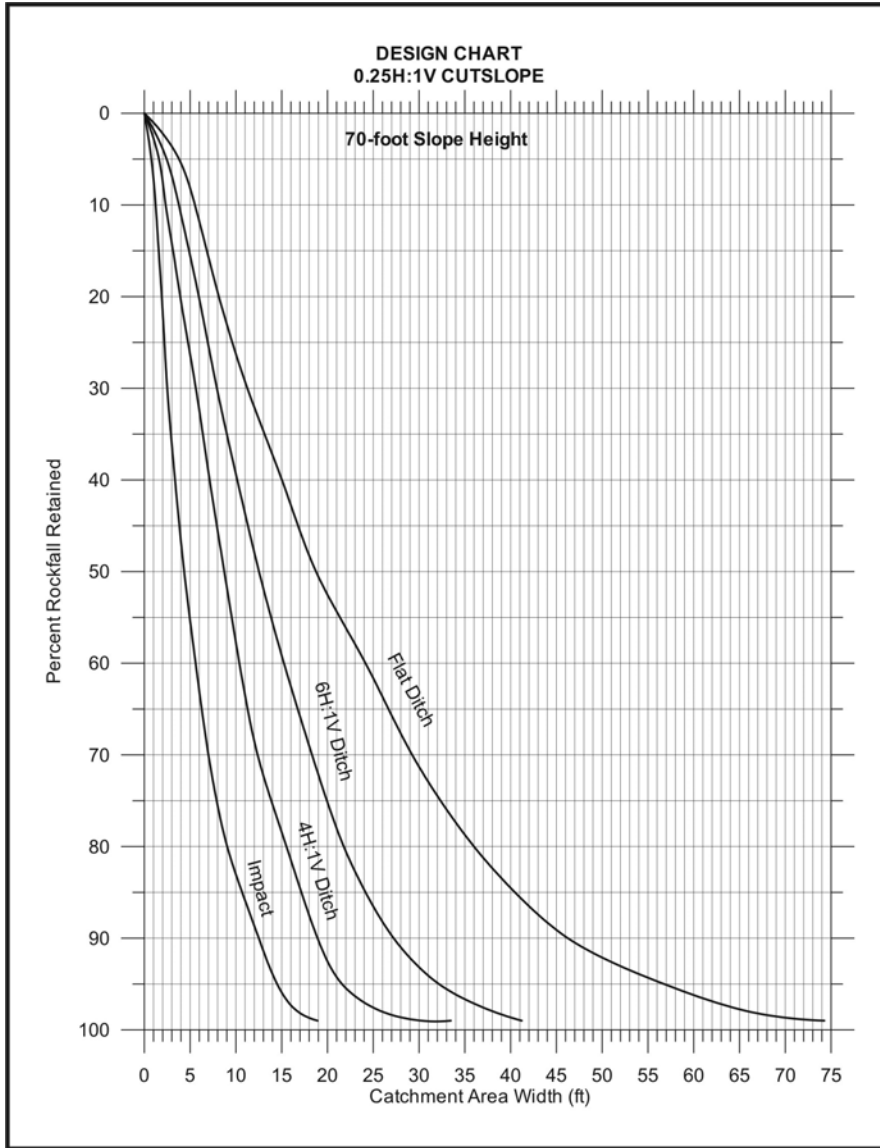

**Quick Reference - 70-Ft Slope
Catchment Area Width - **W****

Percent Rockfall Retained	Impact W (ft)	Catchment Area Slope		
		4H:1V W (ft)	6H:1V W (ft)	Flat W (ft)
50%	4	9	13	19
75%	8	14	20	32
80%	9	15	22	36
85%	11	17	24	40
90%	12	19	27	46
95%	14	22	32	57
99%	19	33	41	74

Figure 5.9: Design chart for 70-foot high 0.25H:1V cutslopes

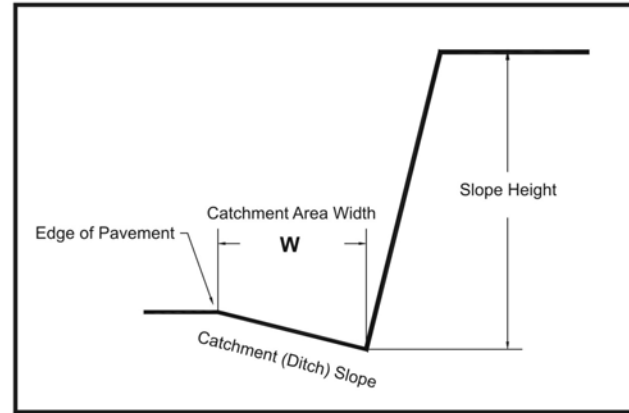
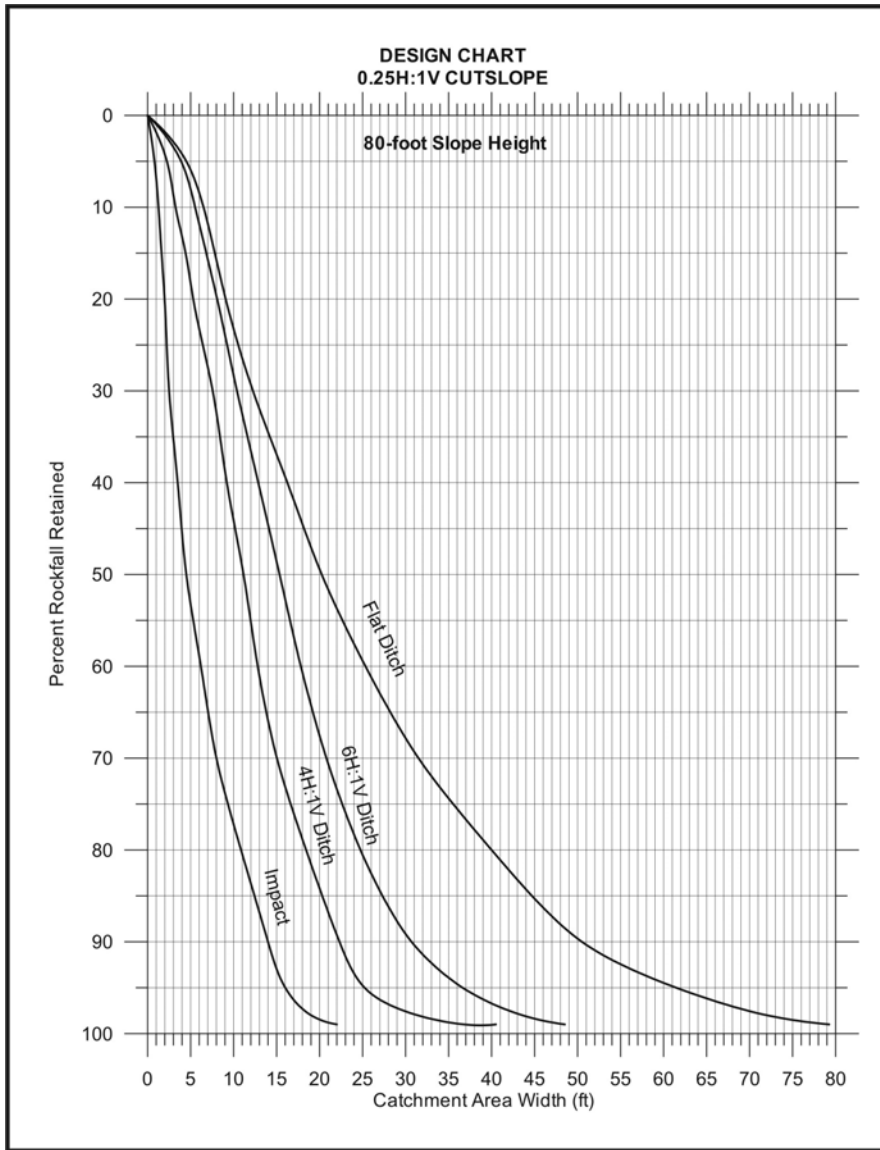

Quick Reference - 80-Ft Slope
 Catchment Area Width - **W**

Percent Rockfall Retained	Impact W (ft)	Catchment Area Slope		
		4H:1V W (ft)	6H:1V W (ft)	Flat W (ft)
50%	4	11	14	20
75%	9	17	23	36
80%	11	18	25	40
85%	12	20	27	45
90%	14	22	31	51
95%	16	25	37	62
99%	22	41	49	79

Figure 5.10: Design chart for 80-foot high 0.25H:1V cutslopes

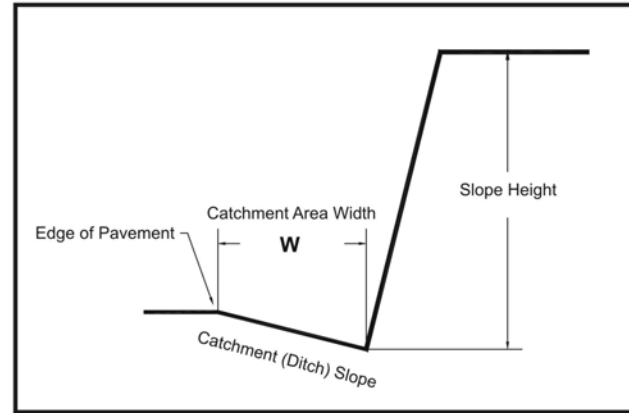
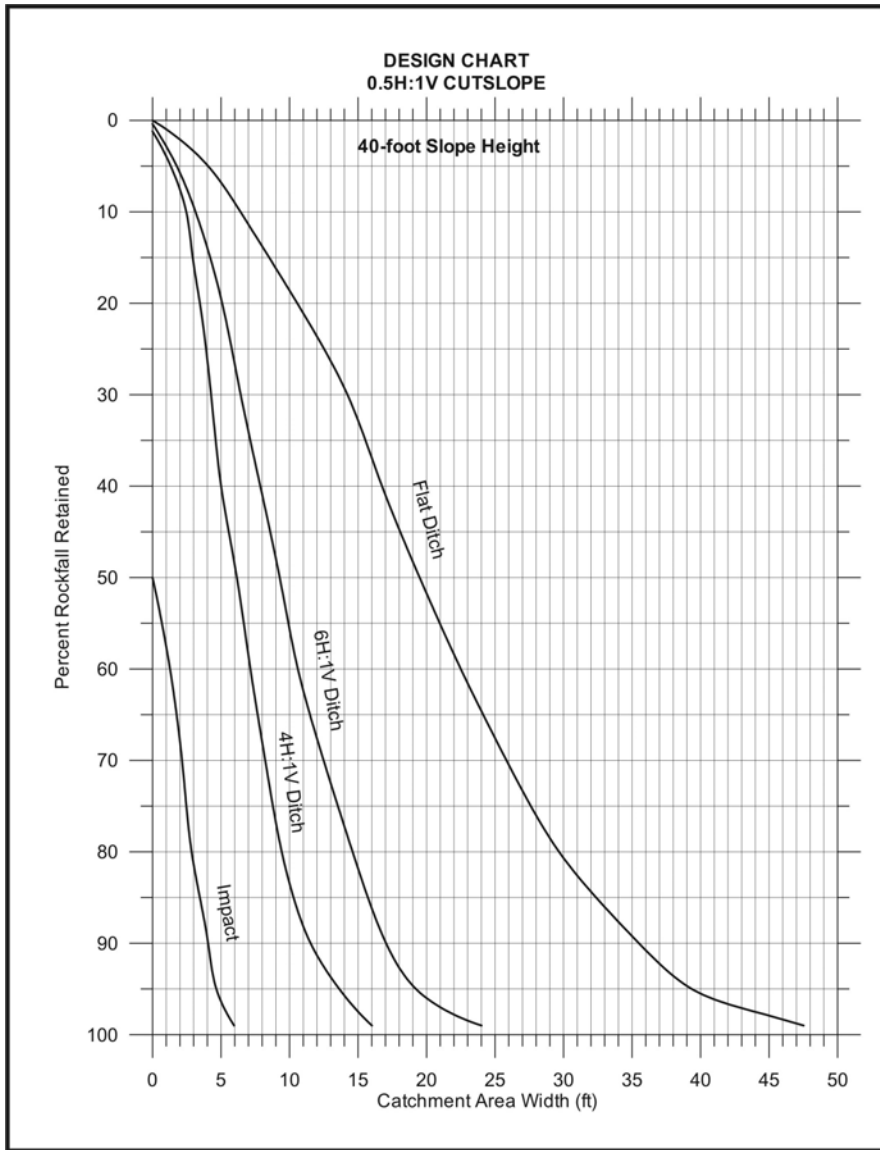

**Quick Reference - 40-Ft Slope
Catchment Area Width - **W****

Percent Rockfall Retained	Impact W (ft)	Catchment Area Slope		
		4H:1V W (ft)	6H:1V W (ft)	Flat W (ft)
50%	0	6	9	19
75%	2	9	14	28
80%	3	9	15	30
85%	3	10	16	32
90%	4	11	17	35
95%	5	14	19	39
99%	6	16	24	48

Figure 5.11: Design chart for 40-foot high 0.5H:1V cutslopes

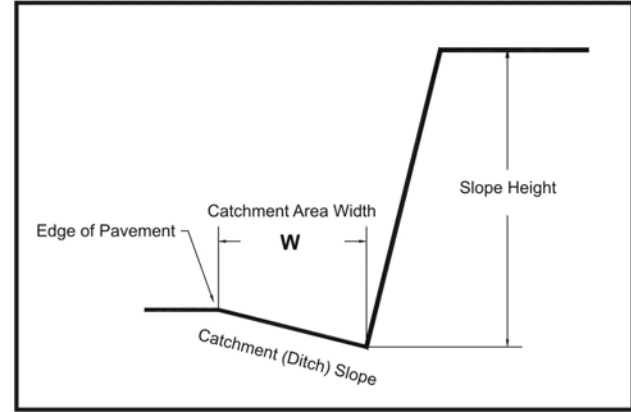
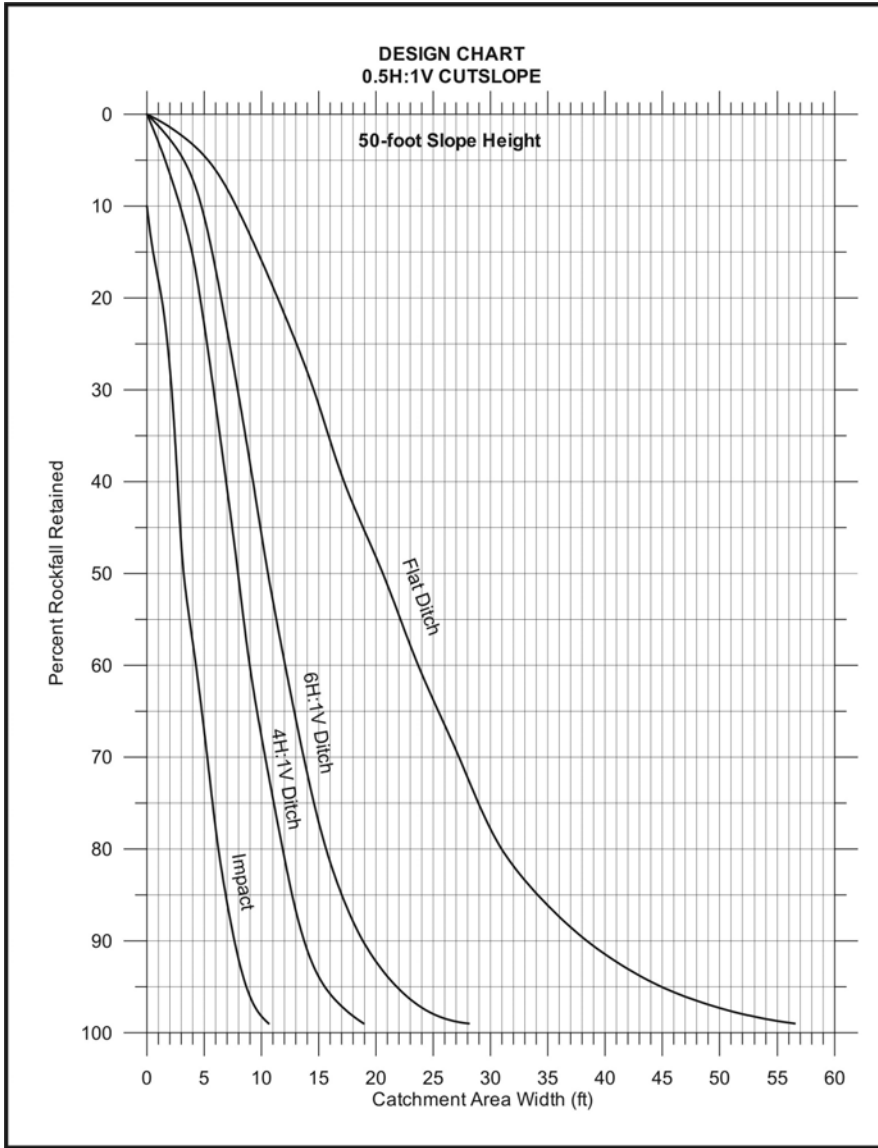

**Quick Reference - 50-Ft Slope
Catchment Area Width - **W****

Percent Rockfall Retained	Impact W (ft)	Catchment Area Slope		
		4H:1V W (ft)	6H:1V W (ft)	Flat W (ft)
50%	3	8	11	21
75%	6	11	15	29
80%	6	12	16	31
85%	7	13	17	34
90%	8	14	19	38
95%	9	16	22	45
99%	11	19	28	57

Figure 5.12: Design chart for 50-foot high 0.5H:1V cutslopes

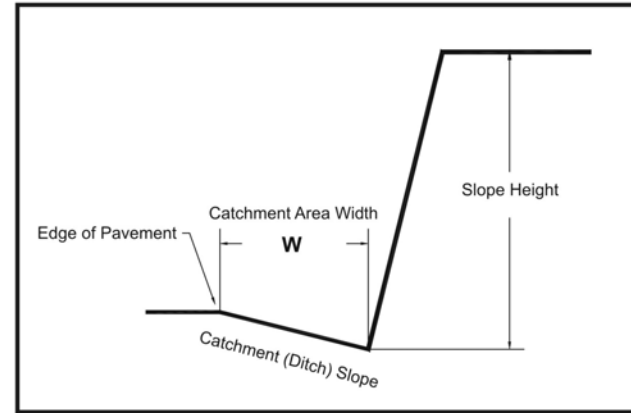
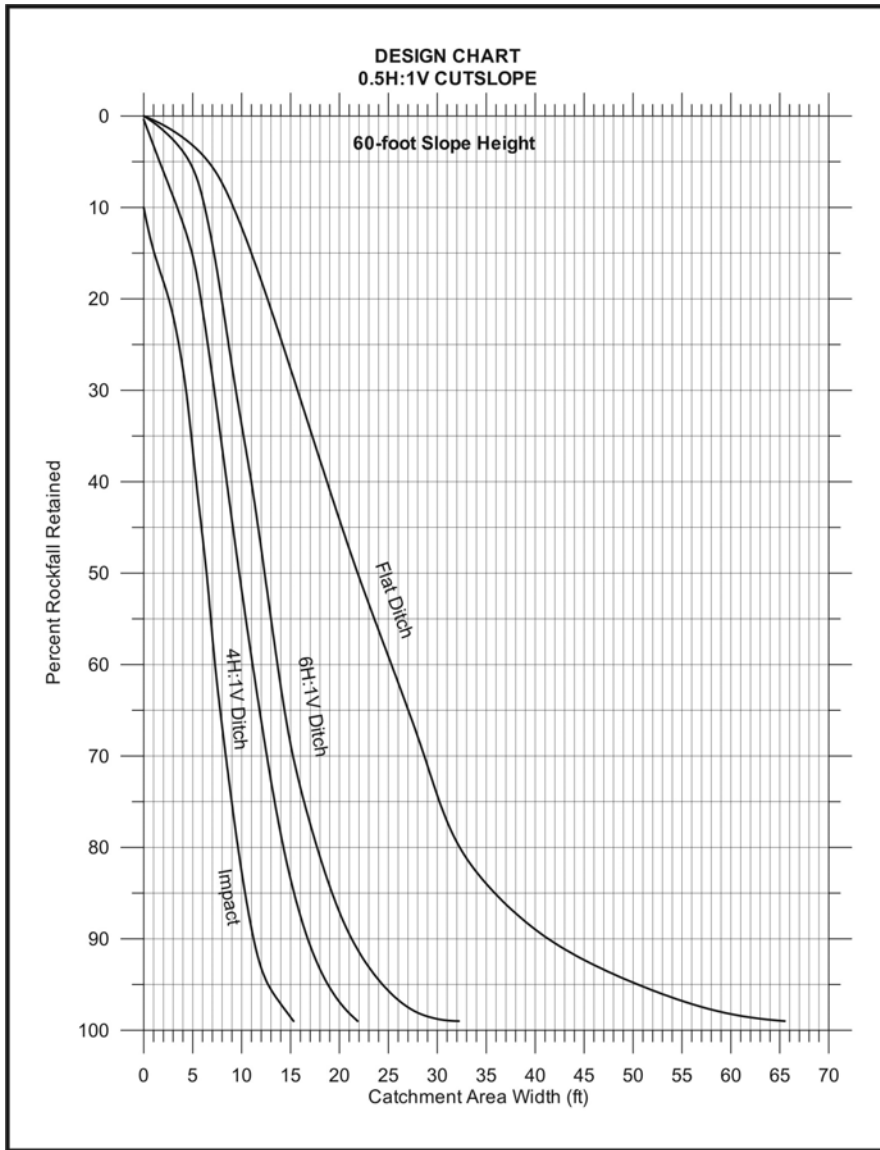

**Quick Reference - 60-Ft Slope
Catchment Area Width - W**

Percent Rockfall Retained	Impact W (ft)	Catchment Area Slope		
		4H:1V W (ft)	6H:1V W (ft)	Flat W (ft)
50%	6	10	12	22
75%	9	13	16	30
80%	10	14	18	32
85%	10	15	19	36
90%	11	17	21	41
95%	13	19	24	51
99%	15	22	32	66

Figure 5.13: Design chart for 60-foot high 0.5H:1V cutslopes

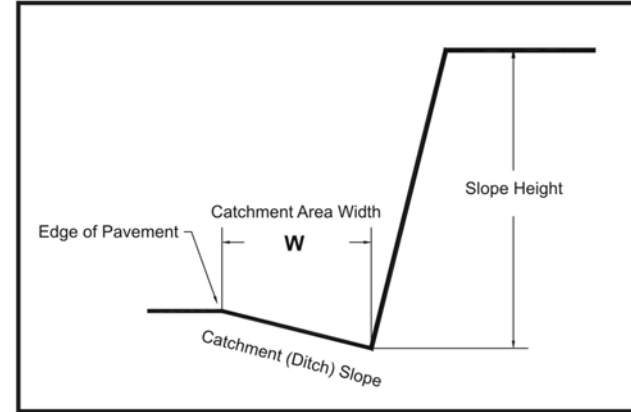
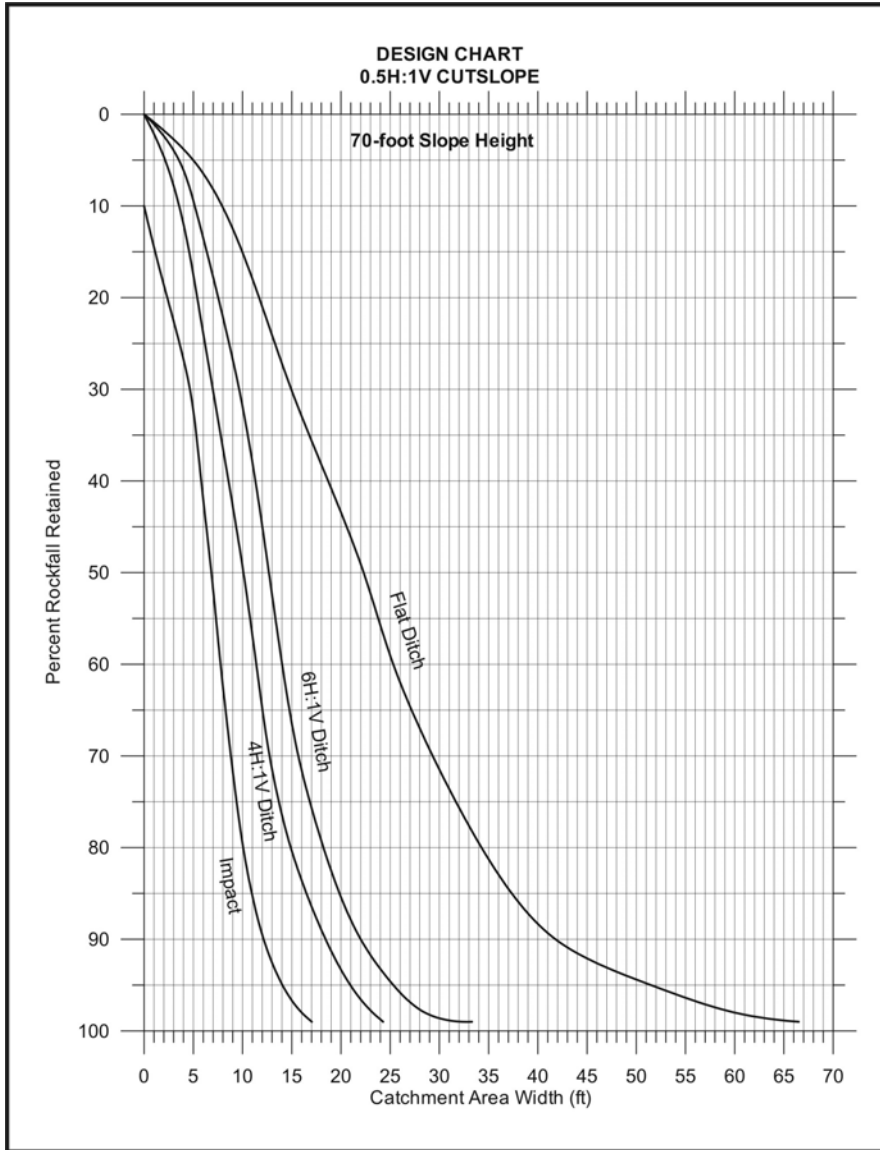

**Quick Reference - 70-Ft Slope
Catchment Area Width - **W****

Percent Rockfall Retained	Impact W (ft)	Catchment Area Slope		
		4H:1V W (ft)	6H:1V W (ft)	Flat W (ft)
50%	7	10	13	22
75%	9	14	17	32
80%	10	15	18	34
85%	11	16	20	37
90%	12	18	22	42
95%	14	21	25	52
99%	17	24	33	67

Figure 5.14: Design chart for 70-foot high 0.5H:1V cutslopes

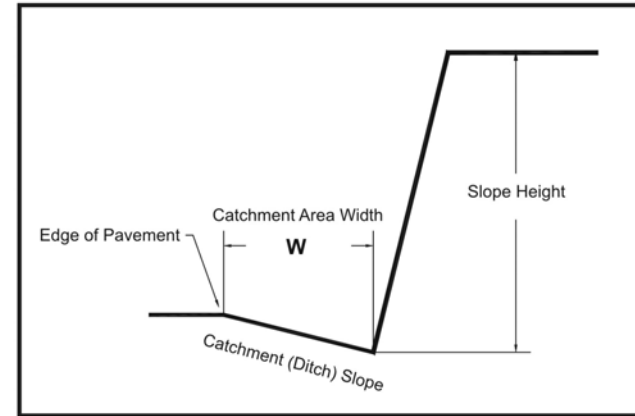
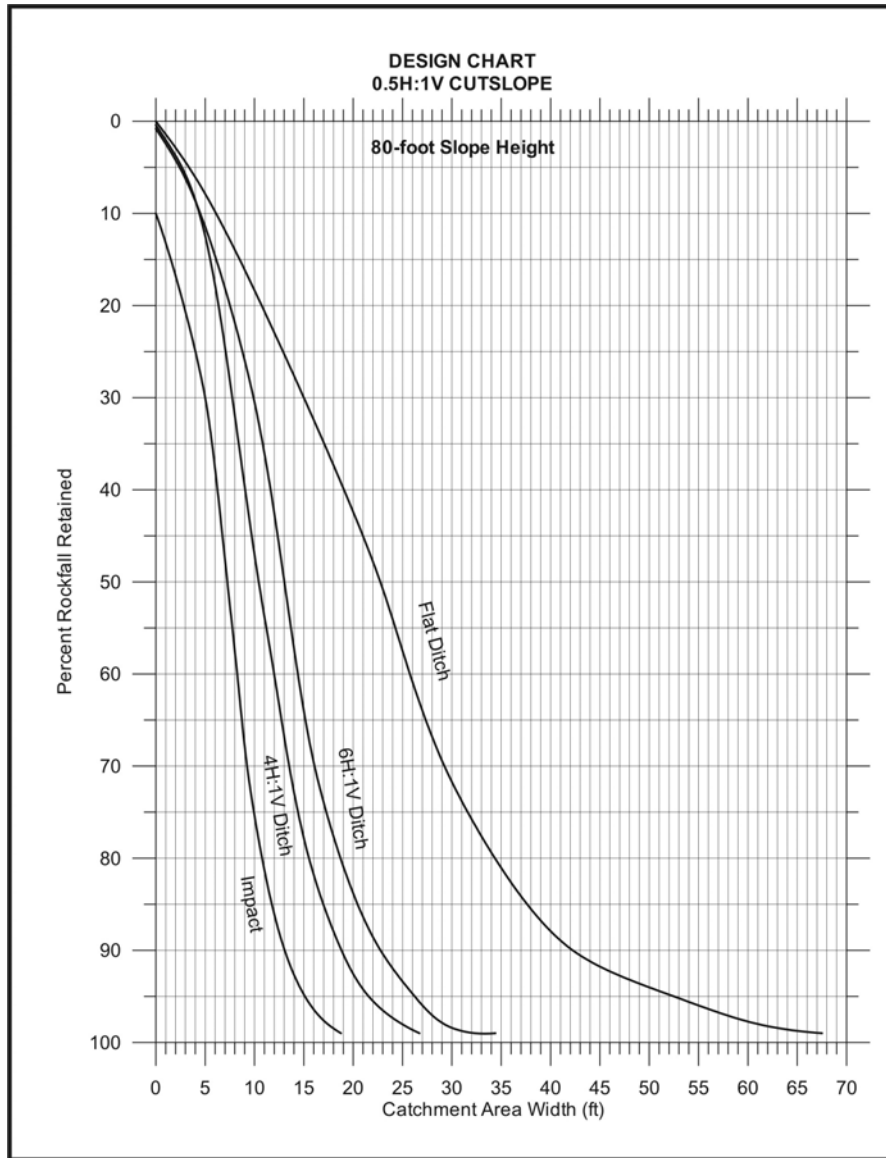

**Quick Reference - 80-Ft Slope
Catchment Area Width - W**

Percent Rockfall Retained	Impact W (ft)	Catchment Area Slope		
		4H:1V W (ft)	6H:1V W (ft)	Flat W (ft)
50%	7	10	13	23
75%	10	14	17	32
80%	11	16	19	34
85%	12	17	20	38
90%	13	19	23	42
95%	15	22	26	53
99%	19	27	34	68

Figure 5.15: Design chart for 80-foot high 0.5H:1V cutslopes

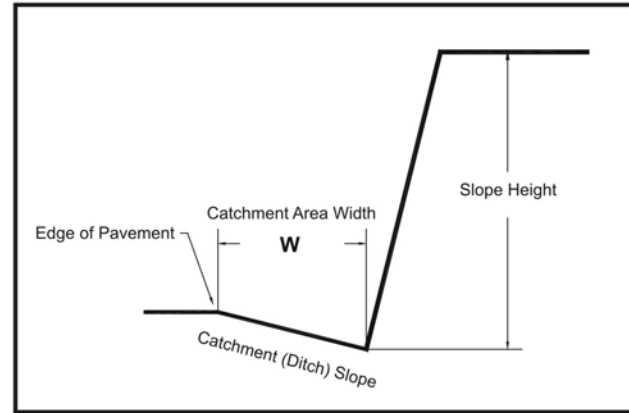
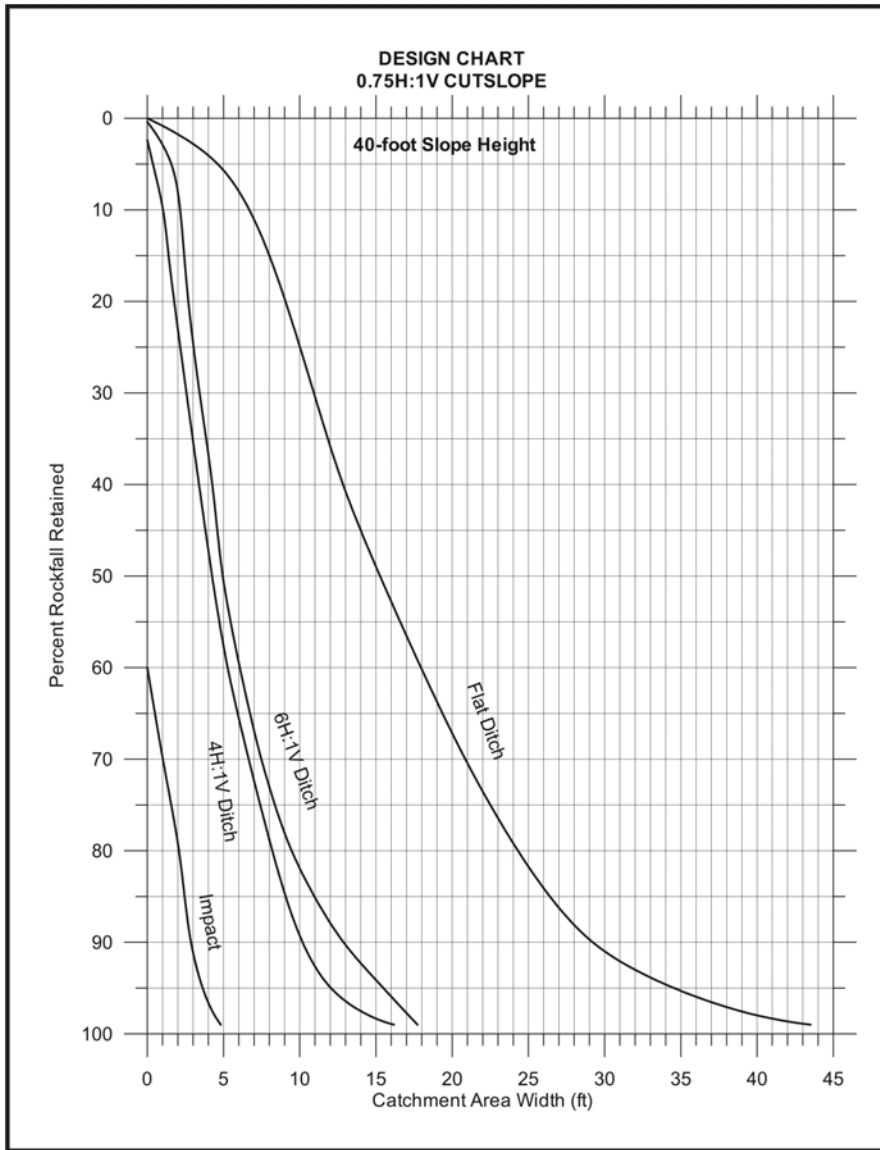

**Quick Reference - 40-Ft Slope
Catchment Area Width - **W****

Percent Rockfall Retained	Impact W (ft)	Catchment Area Slope		
		4H:1V W (ft)	6H:1V W (ft)	Flat W (ft)
50%	0	4	5	15
75%	2	7	8	23
80%	2	8	9	24
85%	2	9	11	26
90%	3	10	13	29
95%	4	12	15	35
99%	5	16	18	44

Figure 5.16: Design chart for 40-foot high 0.75H:1V cutslopes

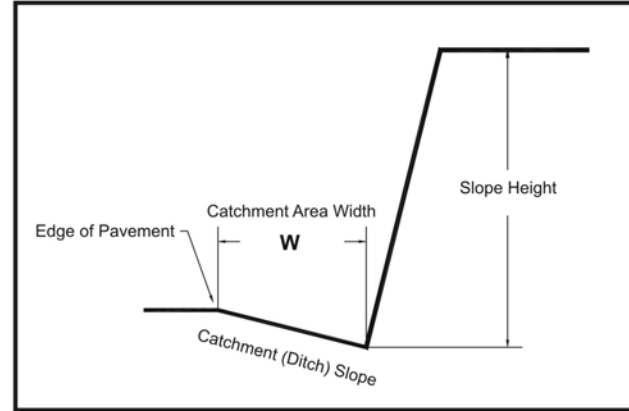
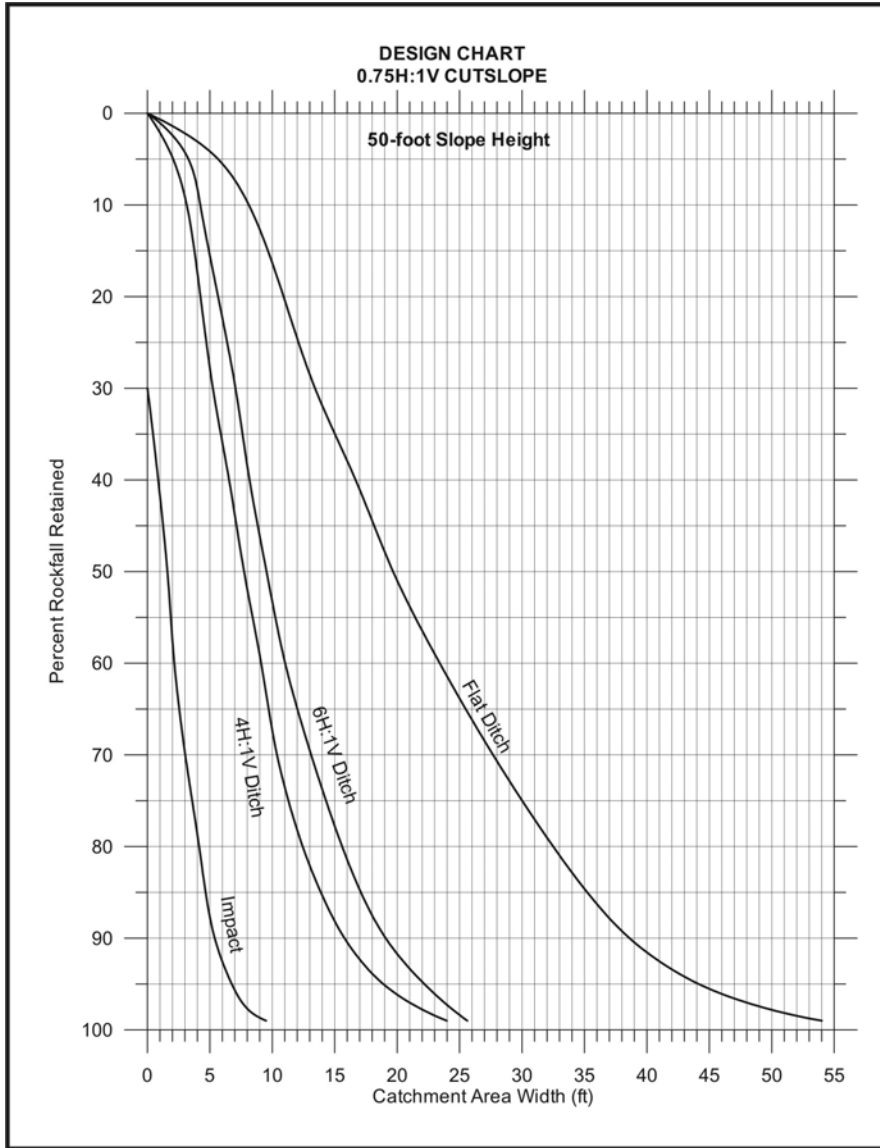

**Quick Reference - 50-Ft Slope
Catchment Area Width - **W****

Percent Rockfall Retained	Impact W (ft)	Catchment Area Slope		
		4H:1V W (ft)	6H:1V W (ft)	Flat W (ft)
50%	2	8	10	20
75%	4	11	14	30
80%	4	12	16	33
85%	5	14	17	35
90%	5	16	19	39
95%	7	19	22	44
99%	10	24	26	54

Figure 5.17: Design chart for 50-foot high 0.75H:1V cutslopes

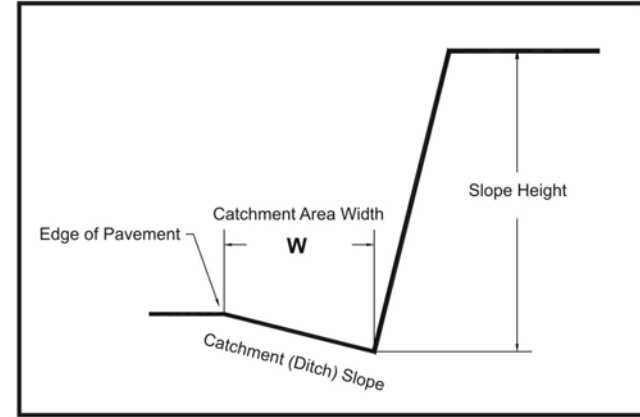
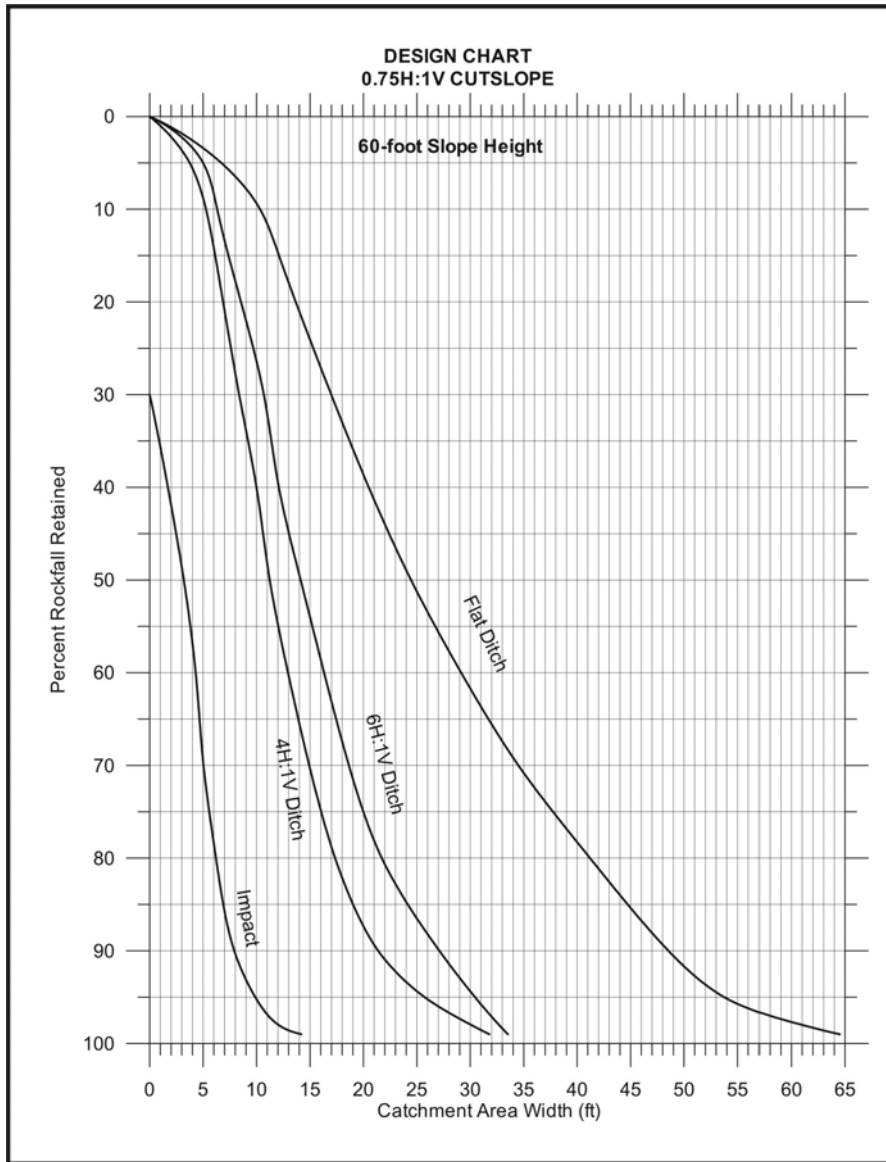

**Quick Reference - 60-Ft Slope
Catchment Area Width - W**

Percent Rockfall Retained	Impact W (ft)	Catchment Area Slope		
		4H:1V W (ft)	6H:1V W (ft)	Flat W (ft)
50%	3	11	14	24
75%	6	16	20	38
80%	6	17	22	41
85%	7	19	24	45
90%	8	21	27	49
95%	10	26	30	54
99%	14	32	34	65

Figure 5.18: Design chart for 60-foot high 0.75H:1V cutslopes

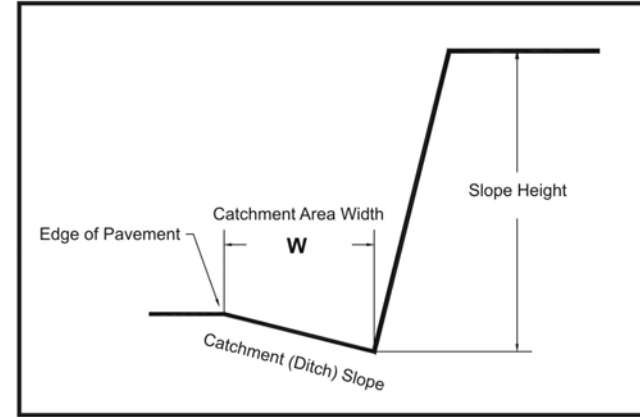
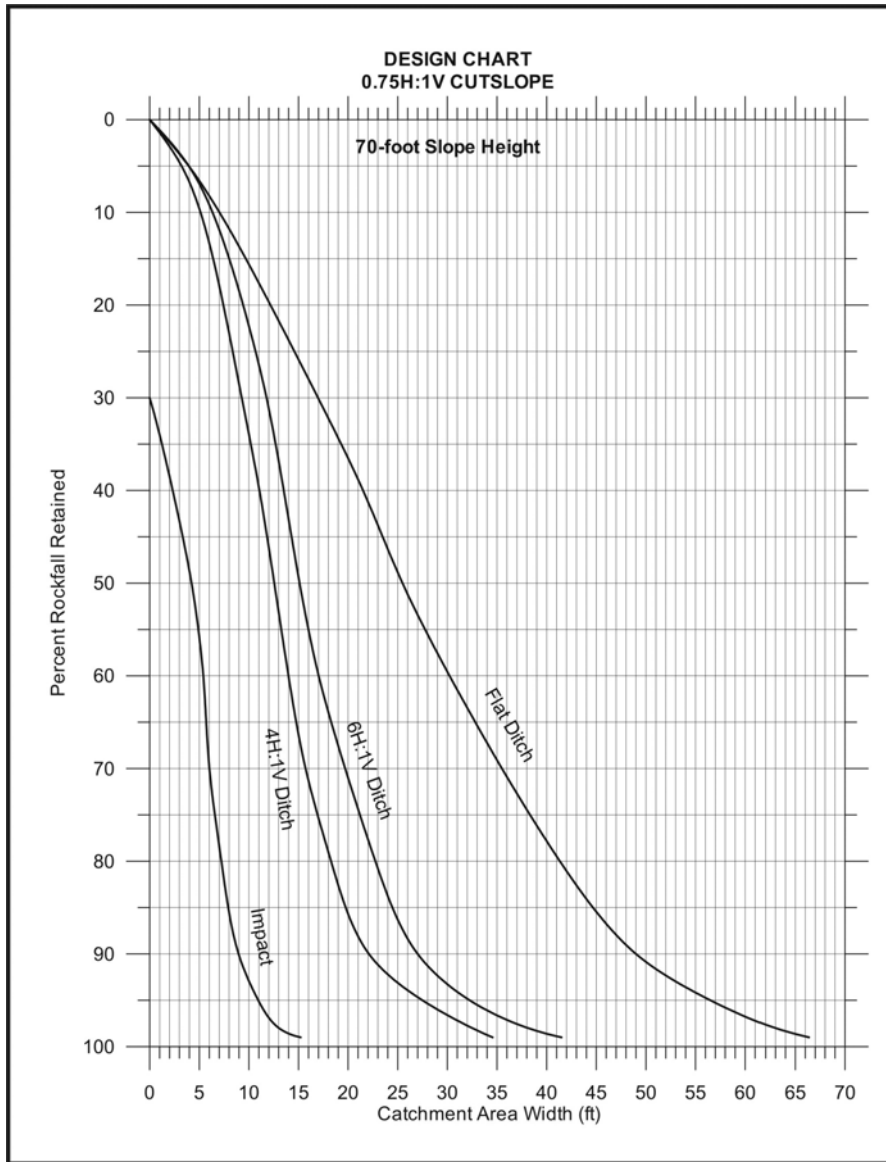

**Quick Reference - 70-Ft Slope
Catchment Area Width - **W****

Percent Rockfall Retained	Impact W (ft)	Catchment Area Slope		
		4H:1V W (ft)	6H:1V W (ft)	Flat W (ft)
50%	4	13	15	25
75%	7	17	21	38
80%	7	18	23	41
85%	8	20	24	45
90%	9	22	27	49
95%	11	28	32	57
99%	15	35	42	66

Figure 5.19: Design chart for 70-foot high 0.75H:1V cutslopes

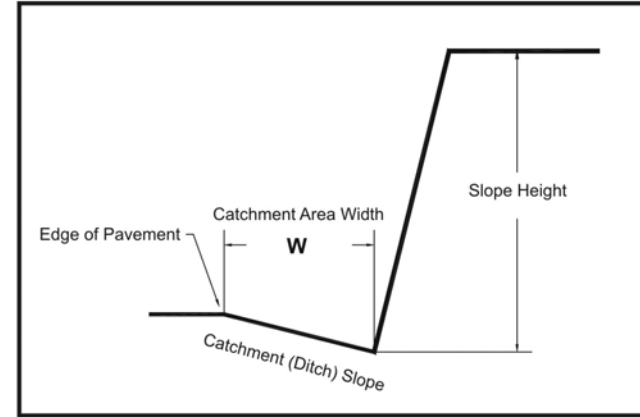
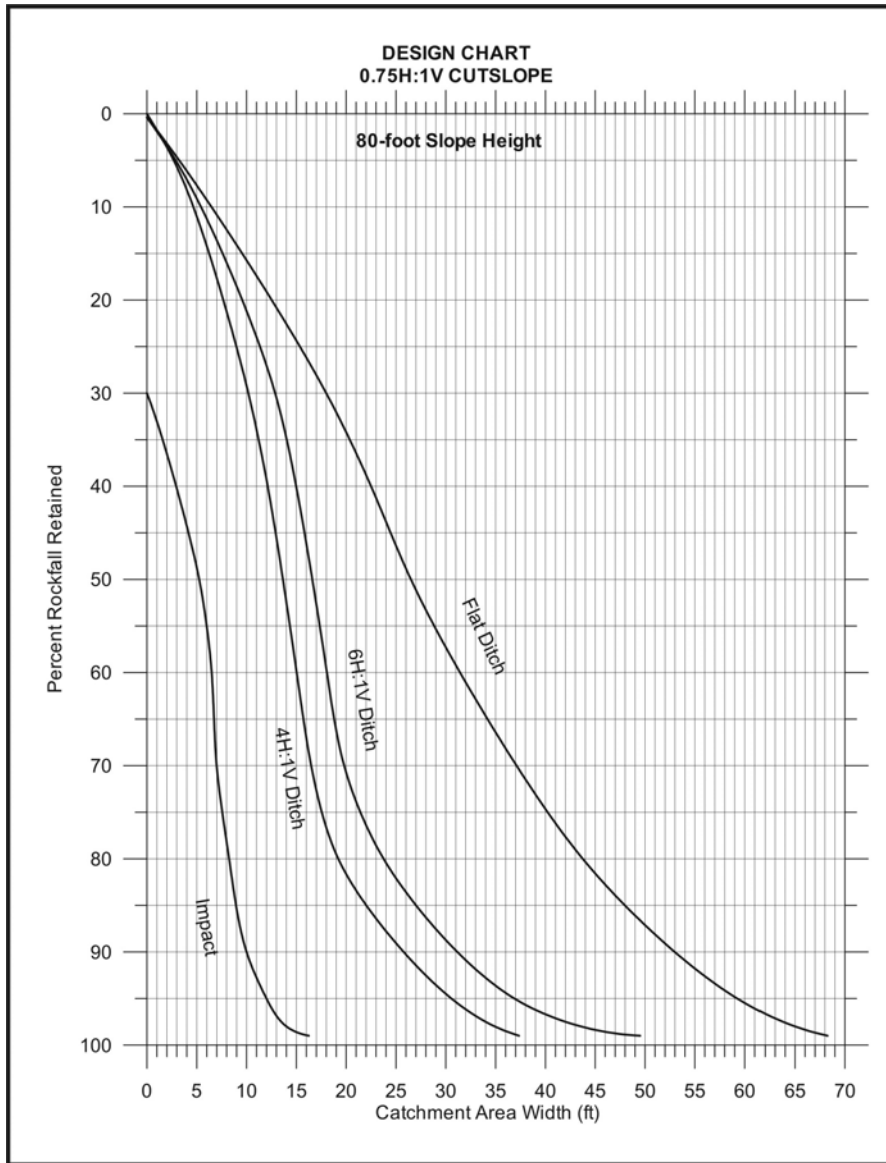

**Quick Reference - 80-Ft Slope
Catchment Area Width - W**

Percent Rockfall Retained	Impact W (ft)	Catchment Area Slope		
		4H:1V W (ft)	6H:1V W (ft)	Flat W (ft)
50%	5	14	17	27
75%	8	18	22	40
80%	8	19	24	44
85%	9	22	27	48
90%	10	26	31	53
95%	12	31	37	59
99%	16	37	50	68

Figure 5.20: Design chart for 80-foot high 0.75H:1V cutslopes

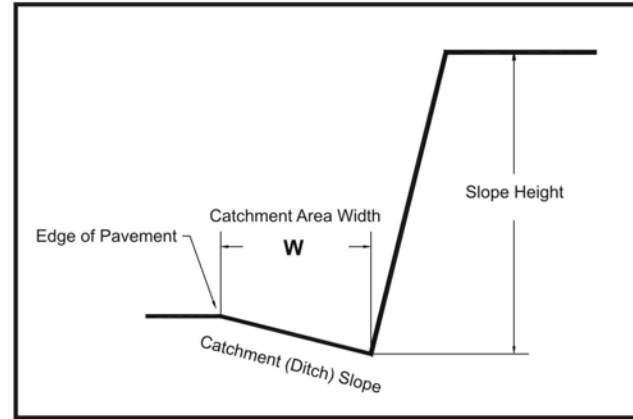
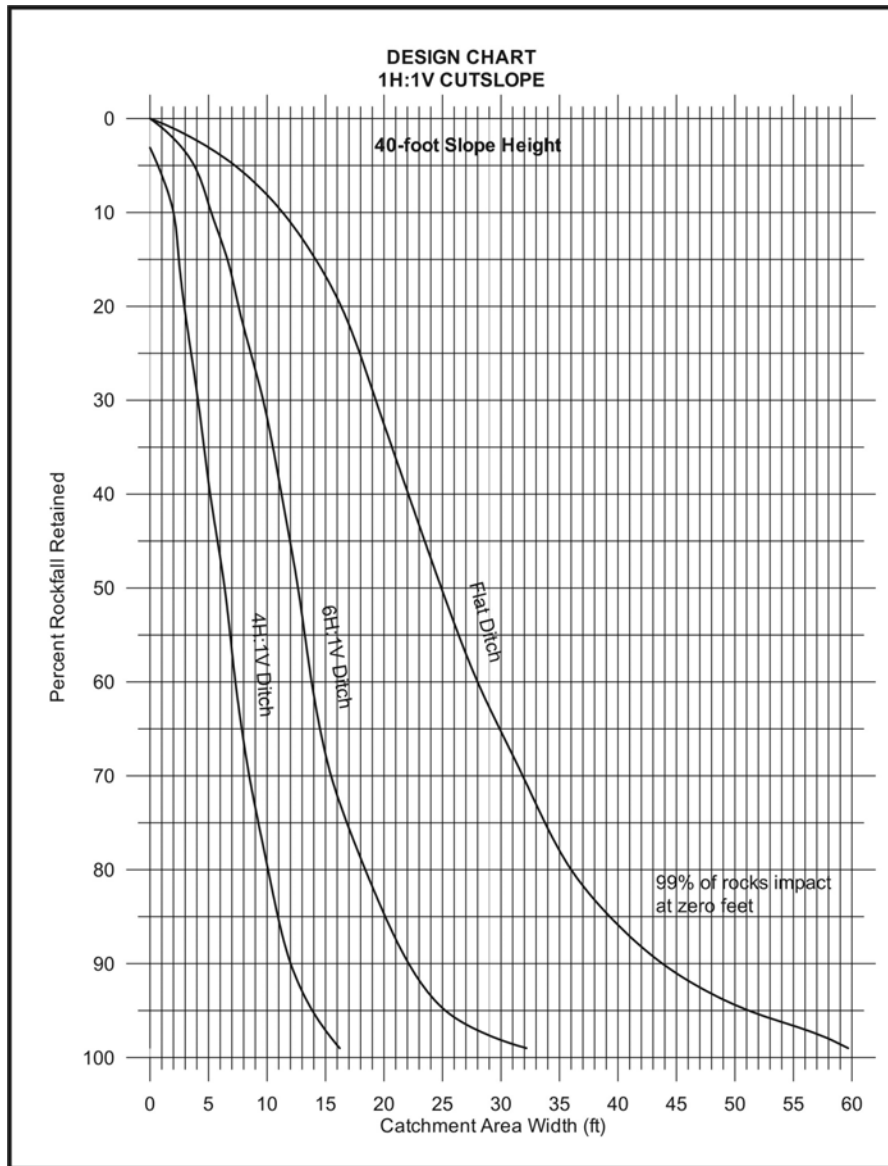

**Quick Reference - 40-Ft Slope
Catchment Area Width - **W****

Percent Rockfall Retained	Impact W (ft)	Catchment Area Slope		
		4H:1V W (ft)	6H:1V W (ft)	Flat W (ft)
50%	0	6	13	25
75%	0	9	17	34
80%	0	10	18	36
85%	0	11	20	39
90%	0	12	22	44
95%	0	14	25	51
99%	0	16	32	60

Figure 5.21: Design chart for 40-foot high 1H:1V cutslopes

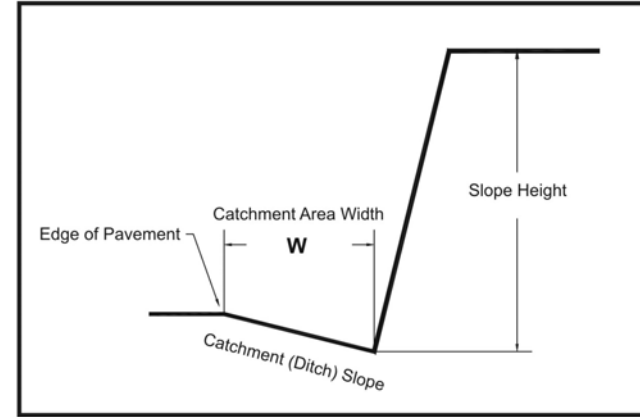
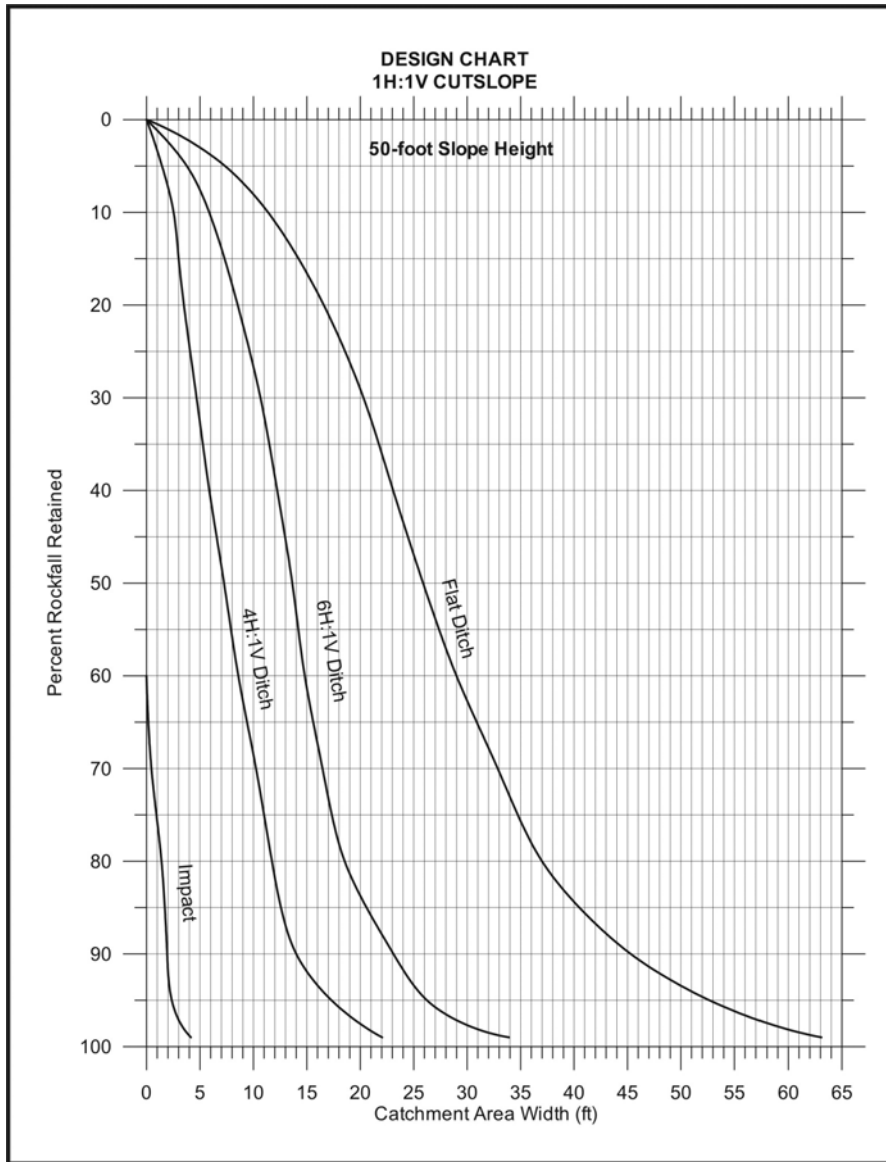

Quick Reference - 50-Ft Slope Catchment Area Width - W				
Percent Rockfall Retained	Impact W (ft)	Catchment Area Slope		
		4H:1V W (ft)	6H:1V W (ft)	Flat W (ft)
50%	0	7	14	26
75%	1	11	17	35
80%	1	12	19	37
85%	2	13	21	40
90%	2	14	23	45
95%	2	17	26	53
99%	4	22	34	63

Figure 5.22: Design chart for 50-foot high 1H:1V cutslopes

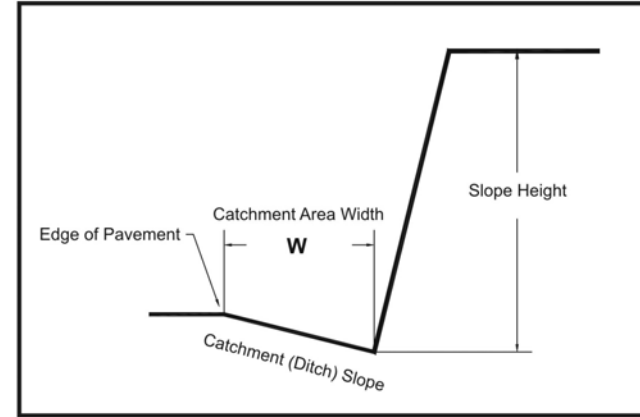
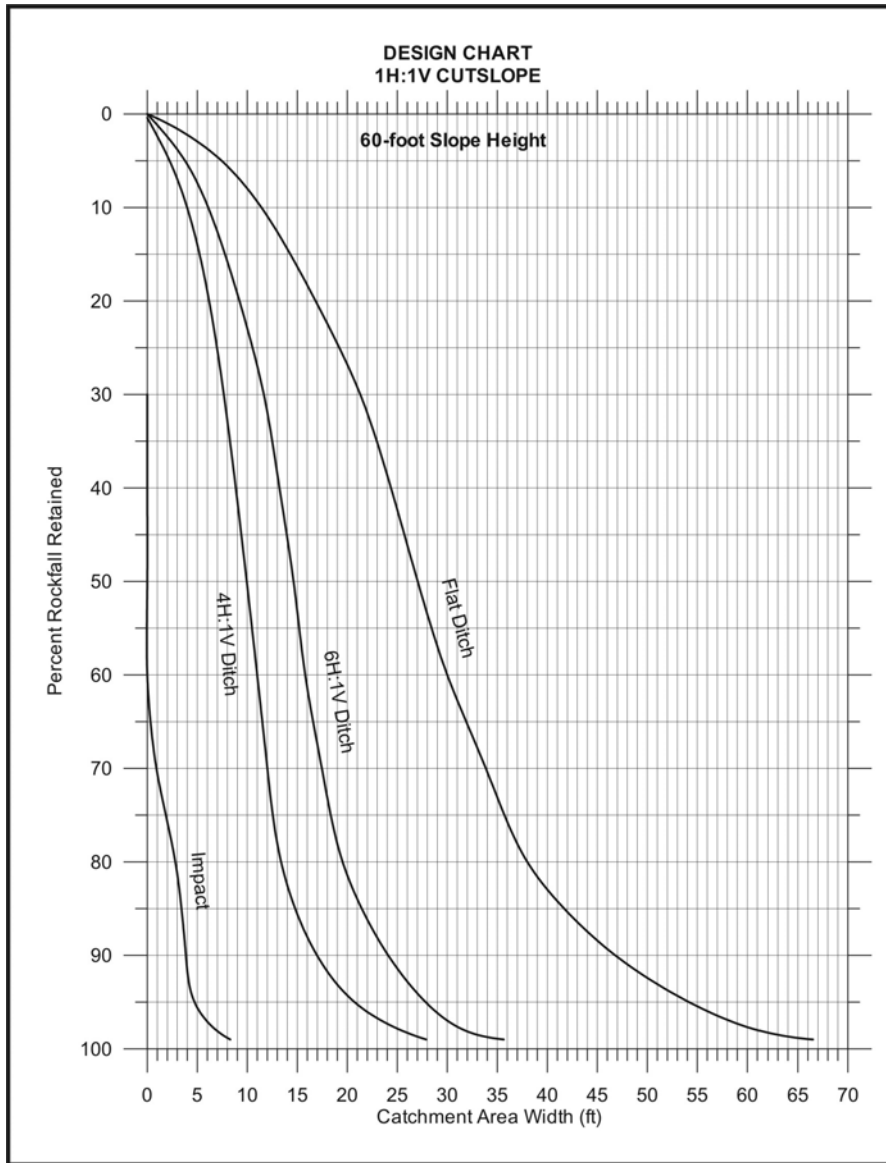

**Quick Reference - 60-Ft Slope
Catchment Area Width - **W****

Percent Rockfall Retained	Impact W (ft)	Catchment Area Slope		
		4H:1V W (ft)	6H:1V W (ft)	Flat W (ft)
50%	0	10	15	27
75%	2	13	18	36
80%	3	13	20	38
85%	3	15	21	42
90%	4	17	24	47
95%	5	21	28	54
99%	8	28	36	67

Figure 5.23: Design chart for 60-foot high 1H:1V cutslopes

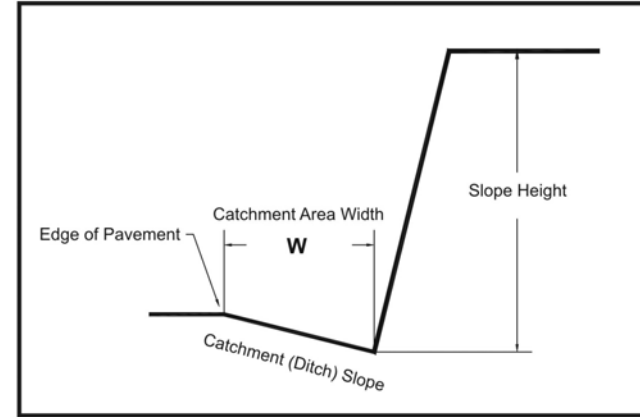
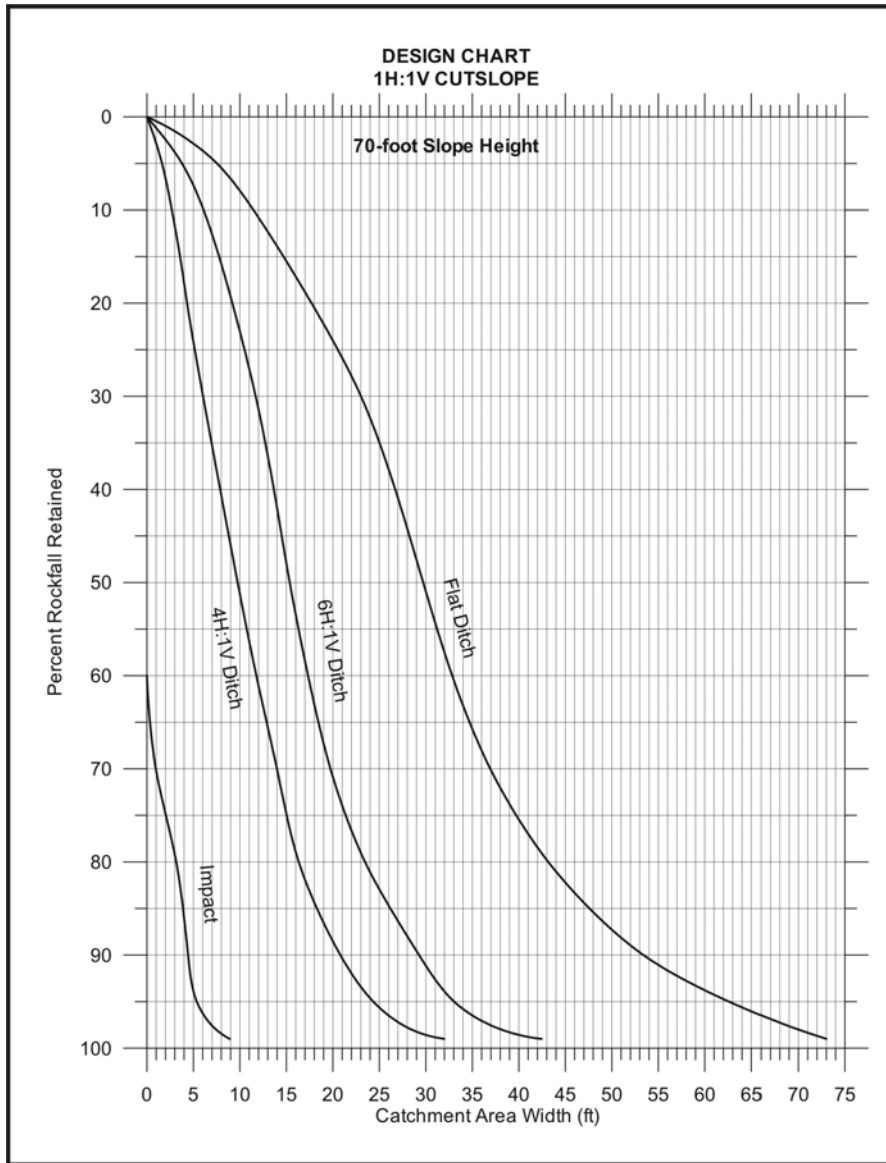

**Quick Reference - 70-Ft Slope
Catchment Area Width - **W****

Percent Rockfall Retained	Impact W (ft)	Catchment Area Slope		
		4H:1V W (ft)	6H:1V W (ft)	Flat W (ft)
50%	0	10	15	30
75%	2	15	21	40
80%	3	16	23	43
85%	4	18	26	48
90%	4	21	29	53
95%	5	24	33	63
99%	9	32	43	73

Figure 5.24: Design chart for 70-foot high 1H:1V cut slopes

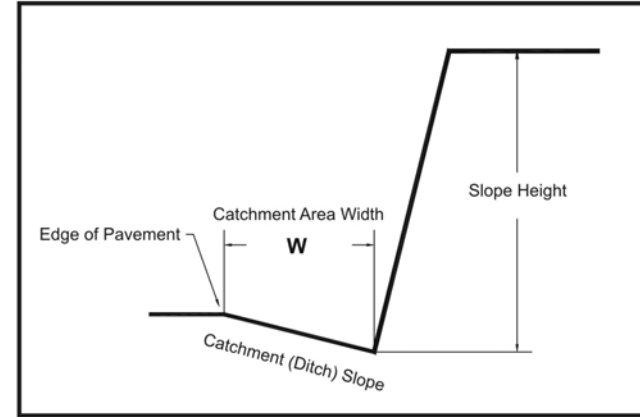
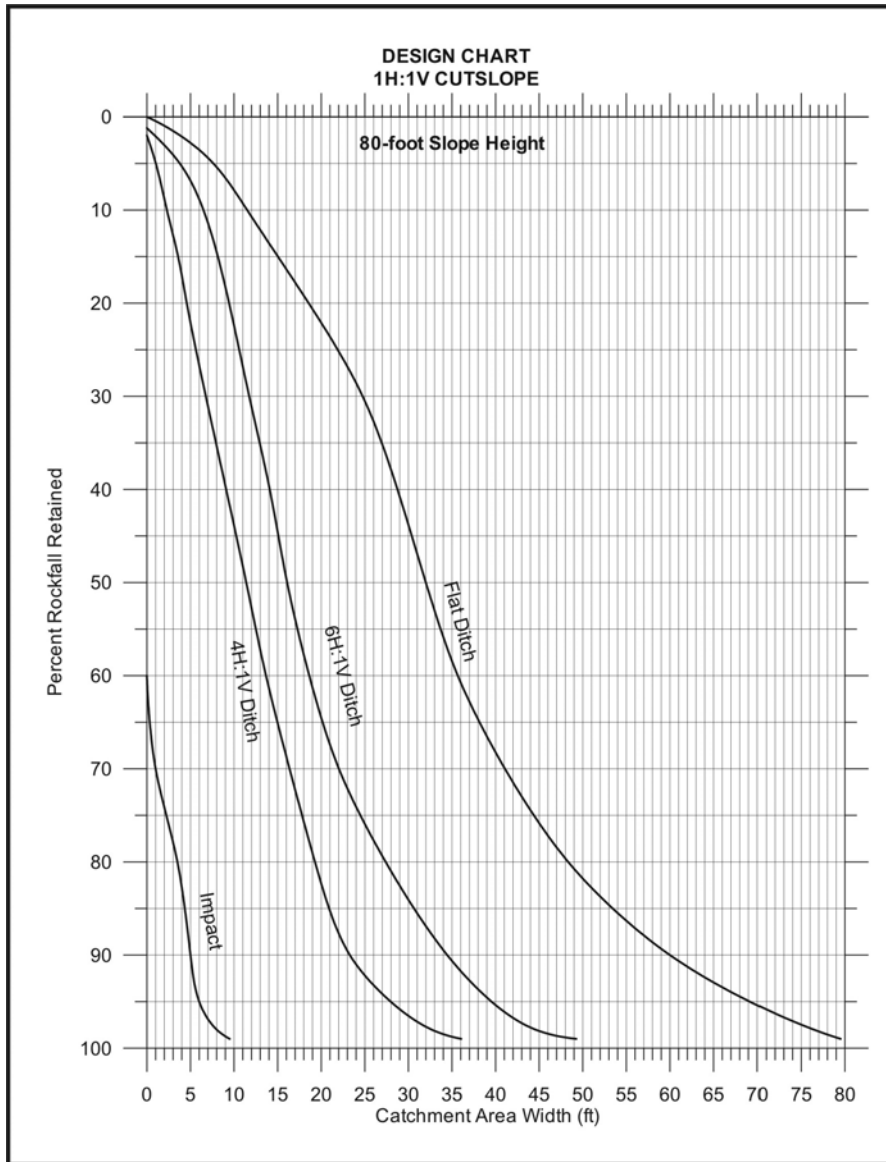

**Quick Reference - 80-Ft Slope
Catchment Area Width - W**

Percent Rockfall Retained	Impact W (ft)	Catchment Area Slope		
		4H:1V W (ft)	6H:1V W (ft)	Flat W (ft)
50%	0	11	16	32
75%	2	18	25	44
80%	4	19	27	48
85%	4	21	31	53
90%	5	23	34	60
95%	6	28	40	69
99%	10	36	49	80

Figure 5.25: Design chart for 80-foot high 1H:1V cutslopes

6.0 CONCLUSIONS

6.1 SUMMARY OBSERVATIONS AND CONCLUSIONS

The following general observations and conclusions may be drawn from the research. Some items may seem intuitively obvious but are worth summarizing here, especially for those who have had limited experience with rockfall behavior. The extensive number of rockfalls observed in this study provides a comprehensive basis for these observations.

- A catchment area's slope, whether flat-bottom or inclined, has insignificant influence on where a falling rock will first impact the catchment area.
- Steeper catchment area slopes dramatically reduce roll out distances.
- Cut slope irregularities, commonly referred to as "launch features," strongly influence a rockfall's point of impact when struck by the falling rock.
- Factors such as the presence of launch features and increasing slope height are key to the development of preferred rockfall paths.
- "Launched" rocks tend to have greater impact distances, increasing the spread or dispersion of recorded impacts, compared to rocks that do not strike launch features.
- Launch features change a rock's vertical drop to horizontal displacement. Typically, the higher the rock velocity when it strikes a launch feature, the greater the horizontal displacement.
- Higher slopes and flatter catchment areas produce rockfall roll out distances that are more widely scattered or variable.
- Higher slopes typically produce larger average roll out and impact distances.
- Higher slopes produce impact distances that are more variable.
- Large roll out distances are possible when a falling rock's translational momentum is changed into rotational momentum by impacting the slope, especially if the rock strikes near the base of the cut slope.
- On vertical slopes, falling rocks rarely strike the slope in trajectory. They typically drop undisturbed into the catchment area. Angular momentum is not imparted to the falling rocks, which results in smaller roll out values.

- On flatter slopes (0.75H:1V and flatter) where rocks are rolling down the cut slope, the impact distances are lower, with most rocks entering the catchment area very near the base of the slope.
- On flatter slopes, movement out into the catchment area is due primarily to roll out.
- Rockfall velocities are a function of cut slope angle and height and the amount of time the rocks are in contact with the slope.
- When in contact with the slope, friction decelerates a rockfall, which lowers the resulting energies.
- Because rocks are less often in contact with steeper slopes (free falling or bouncing not rolling), the resulting velocities and energies are higher than for flatter slopes (0.75H:1V or flatter).
- Field testing of a Ritchie catchment area sized to meet the modified FHWA chart for an 80-foot high, 0.25H:1V slope provided a rockfall retention value of 85 percent.
- Compared to field testing results, the computer simulations for 0.25H:1V slopes tended to under-predict the rockfall roll out distances for 80-foot high slopes and over-predict the roll out distances for the 40-foot high slopes, but the simulations still gave reasonable results. Computer simulations produced distributions similar to field testing, and the effects of rock size and catchment area slope were also similar.
- **It is important to have experienced rock slope engineering personnel (engineering geologists/ geotechnical engineers) involved in designing rock slope catchment areas. They should evaluate and decide when it is appropriate to directly use the figures in this report's design charts or to modify the catchment area dimensions shown.**

6.2 FURTHER RESEARCH NEEDS

The research project Technical Advisory Committee members jointly developed the following list of future research needs to further improve rockfall catchment area designs. TAC members are listed in the Acknowledgments section at the beginning of this report.

- Test other rock slope heights (less than 40 feet and greater than 80 feet).
- Compile case studies of in-service existing rock cut slopes to document the performance history of rockfall catchment area design and/or other rockfall mitigation elements.
- Perform some abbreviated testing on existing highway rock cut slopes to check the sensitivity of different catchment area (ditch) shapes and/or different bedding materials.

- Determine the effect on rockfall roll out distance if a portion of catchment area width is pavement.
- Compile and digitize the available rock rolling video footage from ODOT testing and other available sources for use in future rockfall energy research.
- Document more rock rolling energy data – similar to that presented in Appendix E – for use in structural design of different rockfall mitigation elements (barriers, fences, slope mesh, etc.).
- Test to the point of failure commonly used rockfall mitigation measures, such as conventional concrete guardrail, timber-backed conventional concrete guardrail, metal guardrail, and rockfall catch fences, to determine their ultimate structural/rockfall energy absorbing capacity.
- Use ODOT-generated rockfall energy data to help refine computer simulations provided by Colorado Rockfall Simulation Program (CRSP) or other rockfall computer programs.

7.0 REFERENCES

- Brawner, C. O., 1994. "Rockfall Hazard Mitigation Methods." Publication No. FHWA-SA-93-085.
- D'Appolonia Consulting Engineers, Inc., 1979. "Rockfall Analysis." North Carolina Department of Transportation and Highway Safety Report, Raleigh, NC.
- Duffy, John D., 1992. "Field Tests of Flexible Rockfall Barriers." Industrial Research for Brugg Cable Products, Oberbuchsiten, Switzerland.
- Evans, L. E., 1989. "The Design of Catch Bench Geometry in Surface Mines To Control Rockfall." Unpublished Masters Thesis, Department of Mining and Geological Engineering, University of Arizona, Tempe, AZ.
- Federal Highway Administration, 1989. "Rock Slopes: Design, Excavation, Stabilization." Publication No. FHWA-TS-89-045, Turner-Fairbanks Highway Research Center, McLean, VA.
- Hoek, E., 1987. "Rockfall – A Program in Basic for the Analysis of Rockfalls from Slopes." Golder and Associates, Vancouver B.C.
- McCauley, M. L., C. B. W. Works, and S. A. Naramore, 1985. "Rockfall Mitigation." California Department of Transportation Report, Sacramento, CA.
- Pfeiffer, T. J. and J. A. Higgins, 1990. "Rockfall Hazard Analysis Using the Colorado Rockfall Simulation Program." Transportation Research Record, No. 1288, Washington, D.C., pp. 117-126.
- Pierson, L. A., S. A. Davis, and T. J. Pfeiffer. 1994. "The Nature of Rockfall as the Basis for a New Catchment Area Design Criteria For 0.25H:1V Slopes." Oregon Department of Transportation, Report No. FHWA-OR-GT-95-05.
- Pierson, L. A., S. A. Davis, and R. VanVickle, 1989. "Rockfall Hazard Rating System." Federal Highway Administration Publication No. FHWA-OR-EG-90-01, Turner-Fairbanks Highway Research Center, McLean VA.
- Ritchie, A. M., 1963. "Evaluation of Rockfall and Its Control." Highway Research Record, No. 17, pp. 13-28.
- Wu, S., 1987. "Rockfall Evaluation by Computer Simulation." Transportation Research Record, No. 1031, pp. 1-5.

