

PROCEEDINGS OF THE FIRST NORTH AMERICAN CONFERENCE ON
LANDSLIDES, VAIL, COLORADO, U.S.A., JUNE 3-8, 2007

Landslides and Society

Edited by

A. Keith Turner

Colorado School of Mines, Golden, Colorado 80401, U.S.A.

Robert L. Schuster

U.S. Geological Survey, Denver, Colorado 80225, U.S.A.

OMNIPRESS, Madison, Wisconsin, U.S.A

© 2007 The Association of Environmental & Engineering Geologists.
All rights reserved.

Copyright is not claimed on any material prepared by government employees within the scope of their employment.

All material subject to this copyright and included in this volume may be photocopied for the noncommercial purpose of scientific or educational advancement.

Published by The Association of Environmental & Engineering Geologists, PO Box 460518,
Denver, Colorado 80246

Printed in U.S.A.

Library of Congress Cataloging-in-Publication Data

Landslides/slope instability.

(AEG Special Publication; v. 22)

Keynote and invited papers from the 1st North American Landslide Conference co-sponsored by the Association of Environmental & Engineering Geologists, the Geo-Institute of the American Society of Civil Engineers, and the Canadian Geotechnical Society, held at Vail, Colorado, June 3-8, 2007.

Includes bibliographies.

Includes index.

1. Landslides—Congresses. 2. Avalanches — Congresses.

I. Turner, A. Keith II. Schuster, Robert L. III. Association of Environmental & Engineering Geologists. IV. Geo-Institute of the American Society of Civil Engineers. V. Canadian Geotechnical Society. VI. Series.

ISBN 978-0-9754295-2-5

SEVEN DEADLY SINS OF LANDSLIDE INVESTIGATION, ANALYSIS, AND DESIGN

Derek H. Cornforth, former president, Cornforth Consultants, Inc., Portland, Oregon

Abstract: In practicing as a geotechnical consultant for more than 45 years, the author has observed that certain types of error recur in landslide studies and design. These errors, quite apart from their technical ramifications, frequently lead to costly lawsuits and sometimes fatalities.

The seven deadly “sins,” as selected herein, are:

- Failing to recognize pre-existing landslide conditions
- Interpreting the depth of slippage of a landslide from boring logs or test pits instead of inclinometer observations
- Incorrectly interpreting inclinometer data
- Using an inappropriate factor of safety
- Allowing a contractor to remove support from a landslide for extended periods during remedial construction
- Disregarding artesian pressures in design
- Constructing large fills over soft sediments underlain by steeply-inclined bedrock

All such “sins” are avoidable. The paper describes each error, provides one or two illustrative examples, and comments on how they can be avoided. The case histories are, by necessity, brief summaries. More detailed descriptions of some of them are available in Cornforth (2005).

Introduction

Near the end of a geotechnical consulting career that has been largely devoted to landslide studies, the author has observed that certain errors and misjudgments are repeated and can be very costly to the perpetrators. Using data obtained entirely from projects within his experience (including materials made available through legal proceedings), the Author has selected seven categories of landslide-related “sins” and offers, with very brief case histories, examples of each “sin” and how they can be prevented. The case histories are not intended to be complete, but be sufficient to illustrate the “sin” under discussion. In most cases, they are one example amongst several that could be cited.

Discussing the mistakes of others within a technical paper is a sensitive undertaking. However, our profession advances by the continuing development of good practices. The goal of this paper is to help fellow practitioners avoid these costly and embarrassing mistakes in the future.

Sin No. 1. Failing to recognize pre-existing landslide conditions

Pre-existing landslides usually can be recognized by the landform at a site. Therefore, a reconnaissance of the ground by an experienced engineering geologist should be one of the first requirements for developments proposed on hillsides. It is especially needed on proposed pipeline alignments, large subdivisions, and wherever landslide hazard maps indicate a past history of instability. Although this requirement may seem self-evident, owners and developers often rush to construction, omitting this simple step that could forewarn them of potentially unstable ground.



Figure 1. The Capes landslide. General view of slide adjoining the Pacific Ocean.

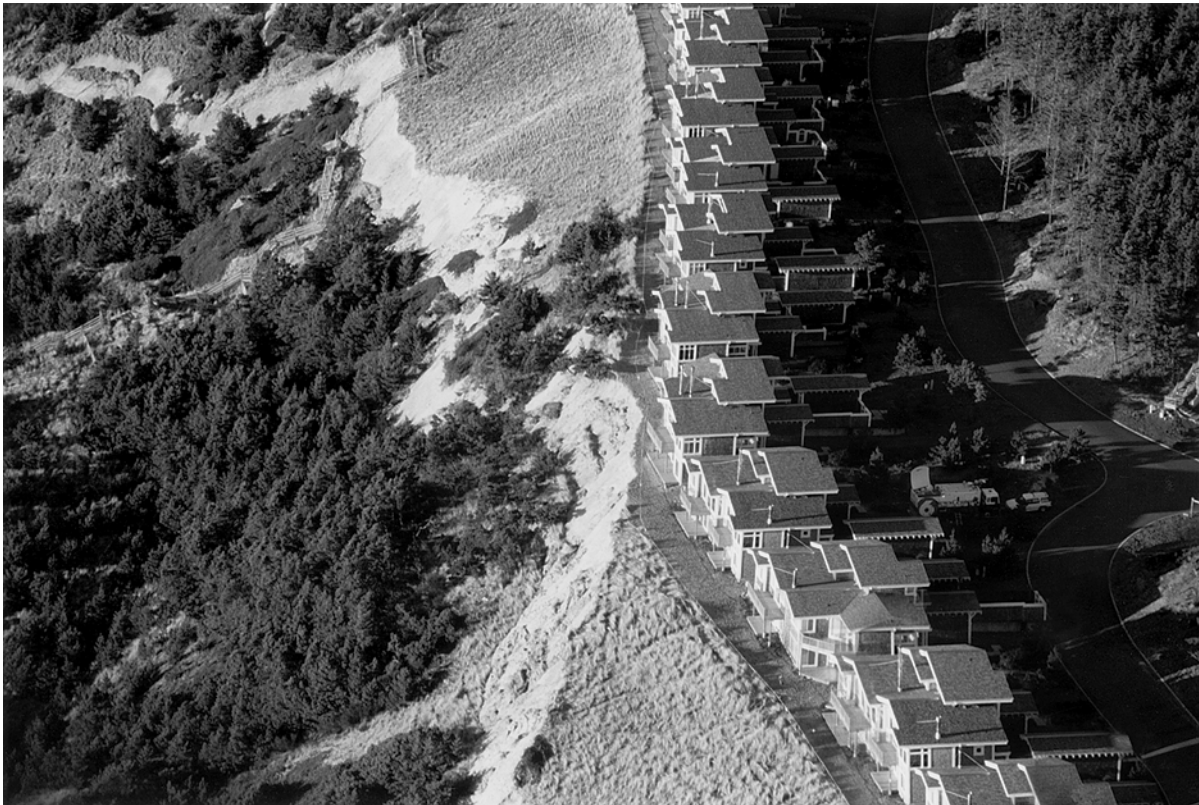

Figure 2. The Capes landslide. Headscarp close to houses on bluff.

Example A: The Capes development, near Oceanside, Oregon

The Capes is an upscale residential development built on the Oregon coast above a steep slope of dense sand. The houses are clustered along the slope top to provide spectacular oceanfront views (Figure 1).

In February, 1998, the ground below the cliff abruptly moved towards the sea creating a landslide headscarp that, in one part of the site, extended to the top of the slope and threatened the safety of several houses (Figure 2). The cause of the landslide was severe erosion of the sandy beach by a winter storm.

The landslide caused many homeowners to file lawsuits against the developers and their consulting engineers. Meetings of lawyers to discuss compensation for homeowners were described by one participant as “chaotic”. During this time, the beach restored itself and landslide movements stopped. Although legal settlements were reached, the landslide has not been treated. It is probable, therefore, that any future severe loss of beach sand will reactivate the slide and cause further movements.

The author was retained by one party to this lawsuit, but did not participate in the ground investigations that occurred after the failure. Based on available information, a triple wedge landslide model ABCD is appropriate (Figure 3). The main slippage occurred near the contact between the dense sand and an underlying stratum of very stiff clay that was a pre-existing slip plane.

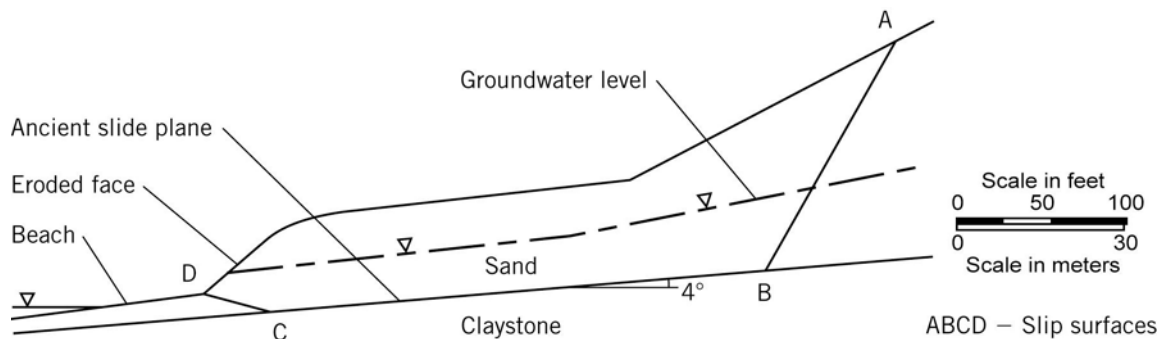

Figure 3. The Capes landslide. Geological cross-section.

This site had been examined by a geotechnical firm before development, but the pre-existing landslide condition at the base of the cliff was missed. An experienced engineering geologist could have recognized the landslide condition from the landform. Although the houses were placed on stable ground at the top of the slope, it is clear from Figure 2 that they were too close to the cliff edge and thus vulnerable to regressive movement of the ground should the pre-existing landslide reactivate.

Example B: Washington Park Reservoirs Slide, Portland, Oregon

In the early 1890s, the city of Portland built two reservoirs on the city’s west side for water supply. The chosen site was a ravine at the base of a long hillside (Figures 4, 5). The project required excavation of 100,000 cu.yds. (76,000 cu.m) of soil from the bottom of the ravine. During construction of the two reservoirs, a large landslide developed upslope that was 1700 feet (520 m) long and 1100 feet (335 m) wide at the base of the slope. The top of the slope was a flat, marshy area – a graben feature of the ancient landslide. Between December, 1894 and October, 1897, downslope movements of up to 3.24 feet (0.99 m) were measured by surface hubs (Clarke, 1904).

During the site investigations, 22 deep shafts and 9 borings showed that the slip surface was 56 to 111 feet (17 to 34 m) below ground (Figure 6), generally occurring within a seam of highly plastic clay. The landslide debris was a heterogeneous mixture of stiff clay and broken rock. The landslide was stabilized by first using pumps to drawdown the water table, followed by digging tunnels along the slip surface to provide a network of interconnecting gravity drains. Today, the landslide creeps downhill at only a fraction of an inch per year.



Figure 4. Washington Park Reservoirs landslide. The two reservoirs are at lower left. Perimeter of slide shown by broken white line.

The Washington Park landslide is an example of ancient landslide terrain reactivation. The excavation for the reservoirs was about 3% of the landslide mass. In a major lawsuit that followed construction, the city was exonerated from liability for residential damages because the judge could not accept that such a minor excavation, relative to the entire landslide mass, could be responsible for the large observed movements. However, in current knowledge, there have been many examples similar to this one showing that minor adverse changes in slope stability can produce disproportionately large movements in pre-existing landslides that are marginally stable prior to the changes.

Ancient landslide terrain covers large areas of the northern United States. Some of these landslides originated in the late Pleistocene (about 8,000 years ago) when high groundwater levels, abundant runoff, and depressed sea and river levels existed. It is of interest that a camel's molar from the Pleistocene era was found during the excavation of landslide debris at the Washington Park reservoirs site described in Example B above (Clarke, 1904).

Comments on Pre-Existing Landslide Conditions

Once a pre-existing landslide condition has been recognized, steps can be taken to discover whether or not the old landslide is currently active. This procedure includes examination of the site for signs of recent movements, enquiries of local residents and city records, and installation

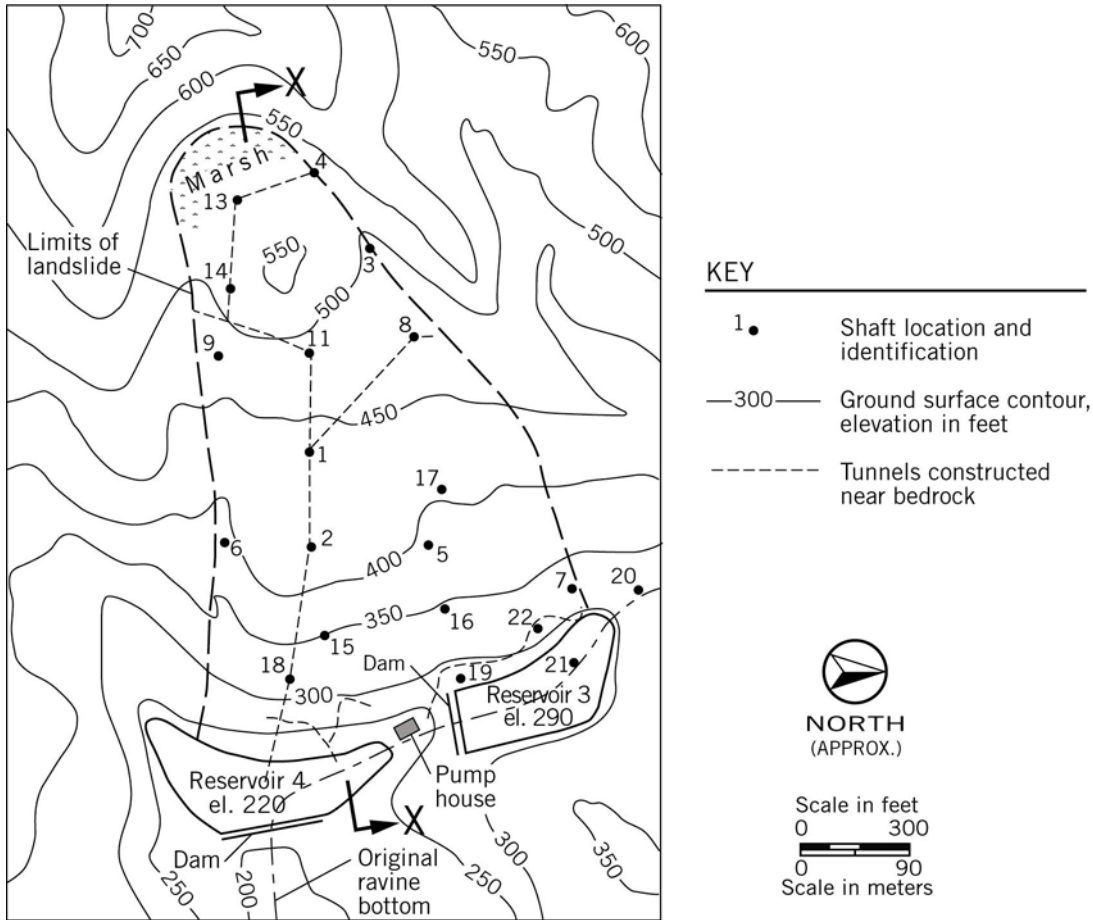

Figure 5. Washington Park Reservoirs landslide: site plan

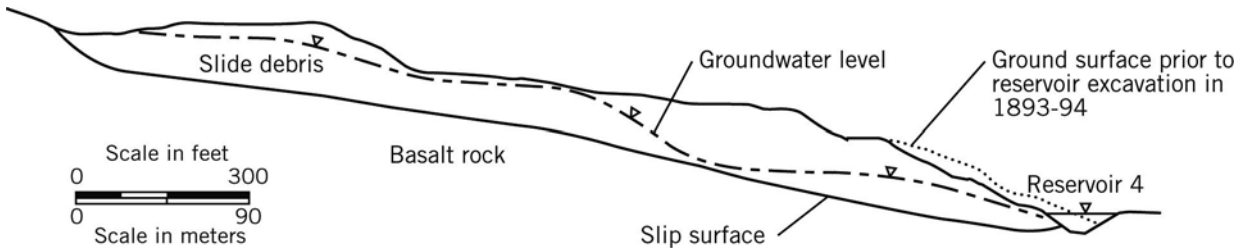

Figure 6. Washington Park Reservoirs landslide: Geological section X-X

of inclinometers to monitor the ground through one or more wet seasons (if feasible due to the owner’s time constraints).

Pre-existing landslides can range from being fully stable to active year-round. A simple classification system (see Cornforth 2005; page 23) is to describe a pre-existing landslide as either: (i) currently stable, (ii) generally stable, but occasionally active during exceptionally high rainfall, (iii) stable during the drier months of the year, but generally active during periods of winter rainfall, or (iv) active throughout the year. These distinctions provide the geotechnical practitioner with a framework to determine what actions need to be taken to provide the necessary stability for a specific project (or to determine if stability measures are feasible).

As a general comment, a pre-existing landslide (such as *ancient landslide terrain*) in a wet temperate climate that appears to be stable should be treated as “marginally” stable unless there is some

redeeming factor at the site to indicate otherwise. Therefore, as a minimum, any development must be designed so that the overall and local stabilities are not reduced as a result of construction.

Lawsuits involving reactivation of pre-existing landslides can be very contentious, with the key technical issue being whether the reactivation is due to natural or manmade cause. The larger movements that produce such lawsuits usually occur during or shortly after a period of intense rainfall. The defense typically takes the position that the rainfall at the time of movement was extraordinary (as an example, that the three-day cumulative rainfall was the highest for the past 40 years). Other natural causes could be erosion from springs, rivers, or sea in combination with high intensity rainfall. The plaintiff position is likely to focus on manmade fills or cuts that destabilize a slope, or on poorly designed control of surface water, such as springs, holding ponds, broken water and sewer pipes, ditches, and drains.

Sin No. 2. Interpreting the depth of slippage in a landslide from boring logs or test pits instead of inclinometer observations

Larger size landslides have to be reliably modeled prior to analysis. The field instrument of choice to measure the slip surface depth is an inclinometer system, comprising a grooved casing (Figure 7) and a probe to measure the tilt of the casing in the ground (Figure 8). The lateral

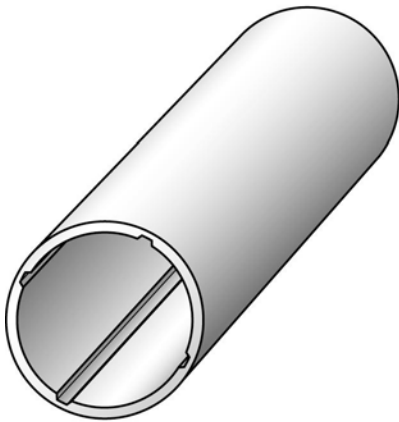

Figure 7. Isometric view of inclinometer casing showing internal longitudinal grooves

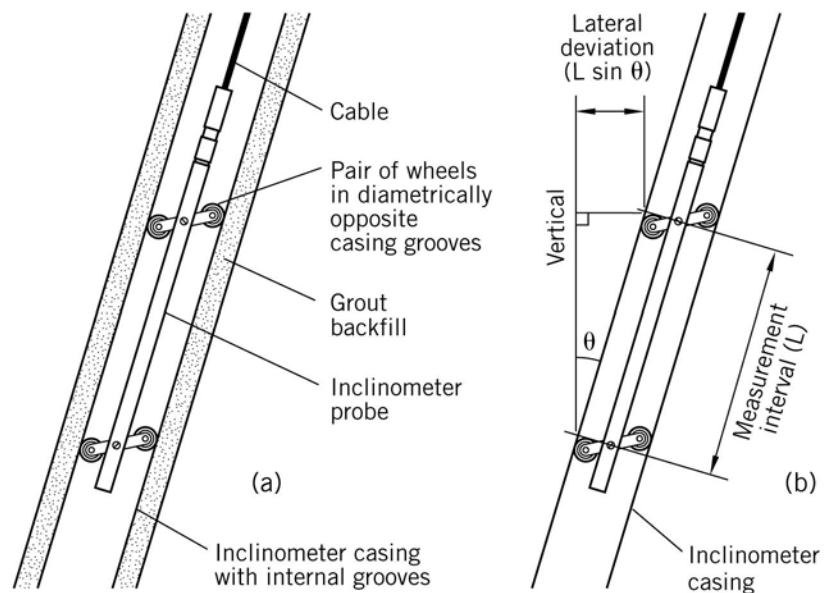

Figure 8. Inclinometer system: (a) probe and casing within borehole. (b) measurement of tilt (courtesy: Slope Indicator Co.)

deflection of the casing can be calculated by comparing a series of tilt readings taken at close intervals along the casing with an initial reading set to measure the change of tilt, if any, at each depth interval (Figure 9). When correctly installed and read, the inclinometer system can detect lateral movements of less than $\frac{1}{4}$ inch (6 mm). The equipment has been available for about 50 years and current versions (available from several manufacturers) provide a mature, reliable technology.

Surprisingly, there are still many landslide investigators who do not use the inclinometer system but instead rely on their personal judgment to estimate the slippage depth. This lack of

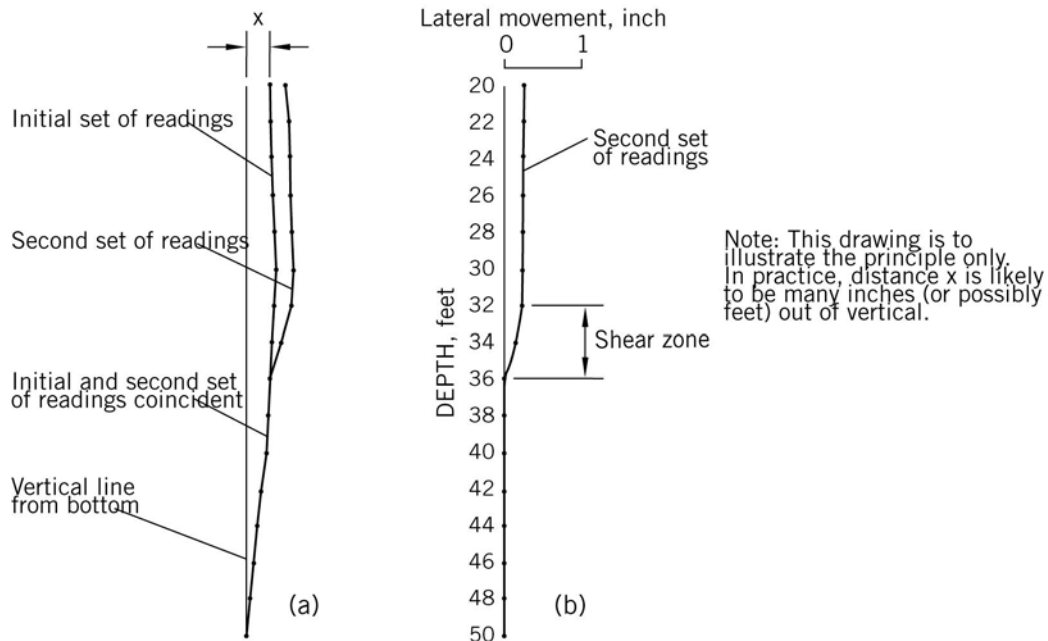

Figure 9. Examples of inclinometer data: (a) shape of casing in the ground for two sets of inclinometer readings (b) determination of shear movement and depth of shear during time interval between reading sets

inclinometer use can be attributed to cost, time to install and read, and general lack of experience in performing the work. However, interpreting field logs or looking at test pits to determine the slippage depth can be seriously flawed, and result in significant errors in modeling a landslide.

Example C: Northern Wasco County Landfill landslide, The Dalles, Oregon

Cell 1 of this landfill expansion was excavated in 1993 with side slopes of 3:1 (horizontal:vertical), and involved removal of 325,000 cu.yds. (250,000 cu.m) of dense silt (Figure 10). In December, 1993, shortly after the excavation had been completed, a crack 700 feet (210 m) long was observed 100 to 200 feet (30 to 60 m) behind the top of the deep cut slope at the south end of the cell. The project consultants dug a 30-foot (9 m) deep test pit near the mid-length of the crack and concluded that the slip surface was at a depth of about 20 feet (6 m) below the ground surface.

In being asked to provide a second opinion, the author suspected that such a long crack would have a slip surface penetrating much deeper than was being estimated from the test pit evidence. Accordingly, two inclinometers were installed in the cut slope. They passed through tuffaceous, very dense fine sandy silt and very dense slightly clayey to clayey silt with relatively high SPT blow counts (Figure 11). Underlying the silts was a very dense stratum of silty fine sand. Because movements had stopped, a small surcharge berm was constructed over the crack at the top of the slope to “nudge” the landslide into additional movement.

The result for inclinometer LT-2 was movement at a depth of 74 to 76 feet (22 to 23 m), as shown on Figure 12, and movement at 114 to 118 feet (35 to 36 m) in LT-1 (not illustrated). Clearly, the estimated depth of the slip surface in the test pit was a large error and could have resulted in serious design repercussions if it had been accepted as correct.

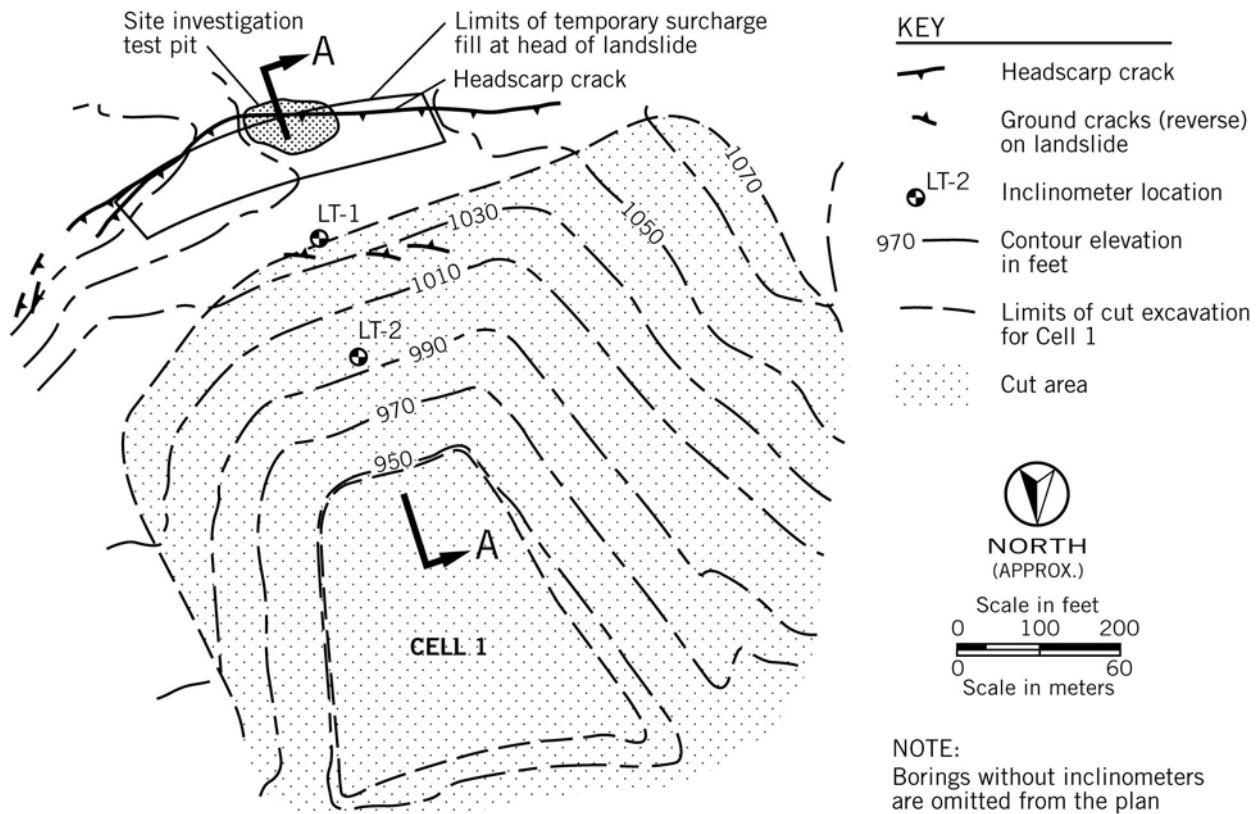

Figure 10. Northern Wasco County landfill landslide. Site plan, Cell 1

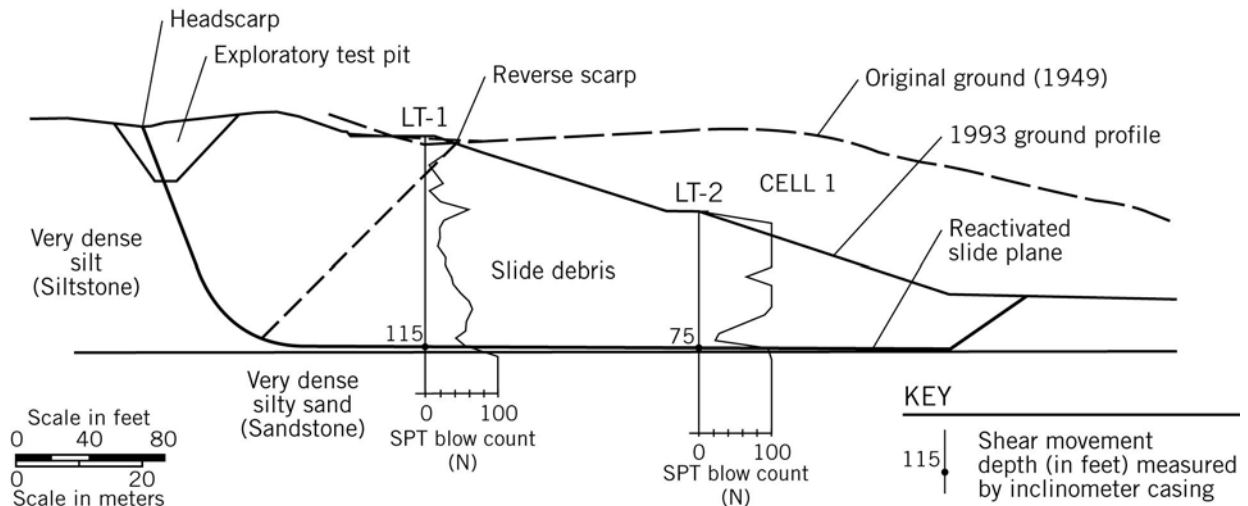

Figure 11. Northern Wasco County Landfill landslide. Section A-A

The landslide was modeled as a triple-wedge failure with slippage occurring along a near-horizontal ancient slip surface. Geological studies confirmed that the site was an ancient landslide.

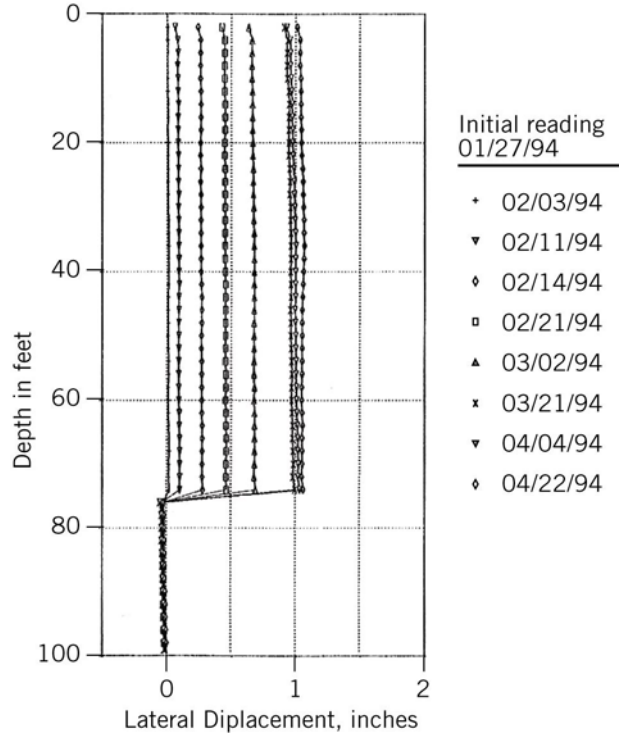

Figure 12. Northern Wasco County Landfill landslide. Inclinometer LT-2

Example D: Faraday landslide, Estacada, Oregon

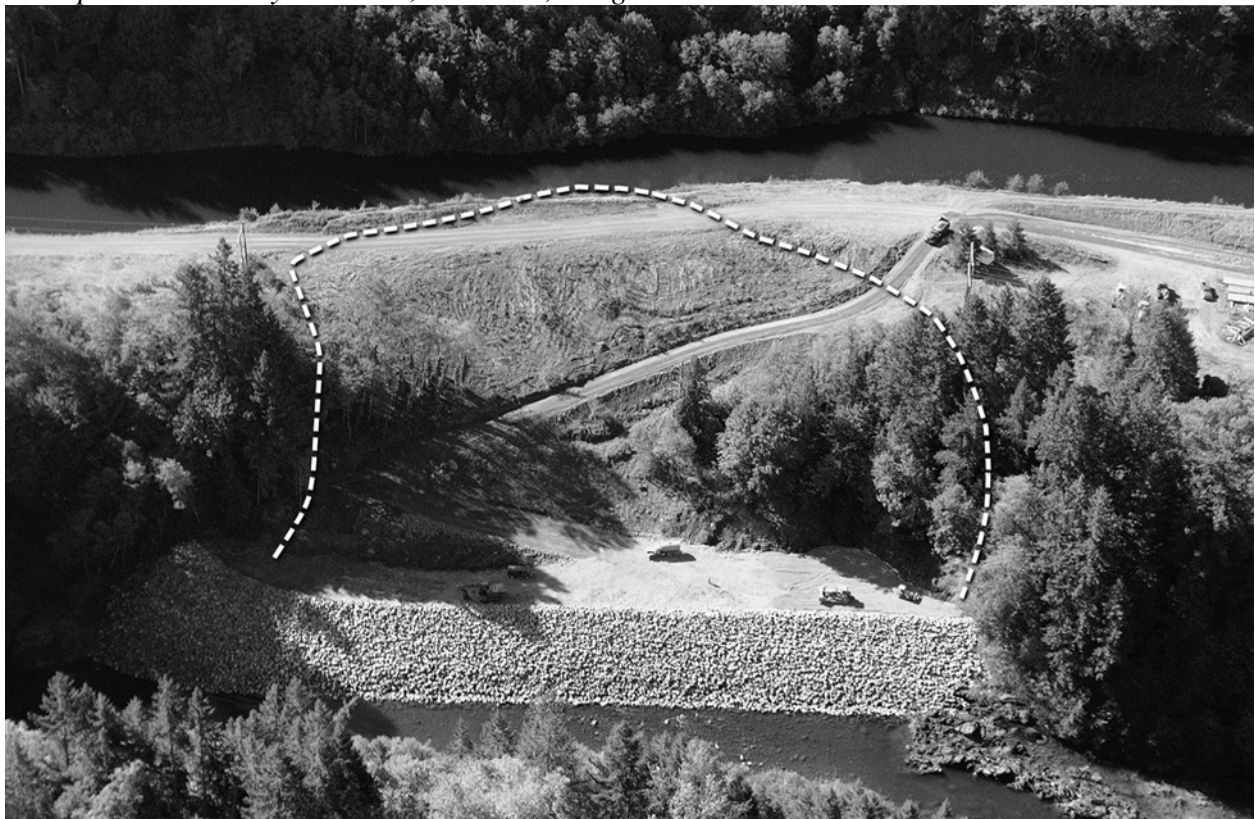

Figure 13. Faraday Canal landslide. Faraday Canal at top. Clackamas River at bottom (with remedial buttress in place). Perimeter of landslide shown by broken white line.

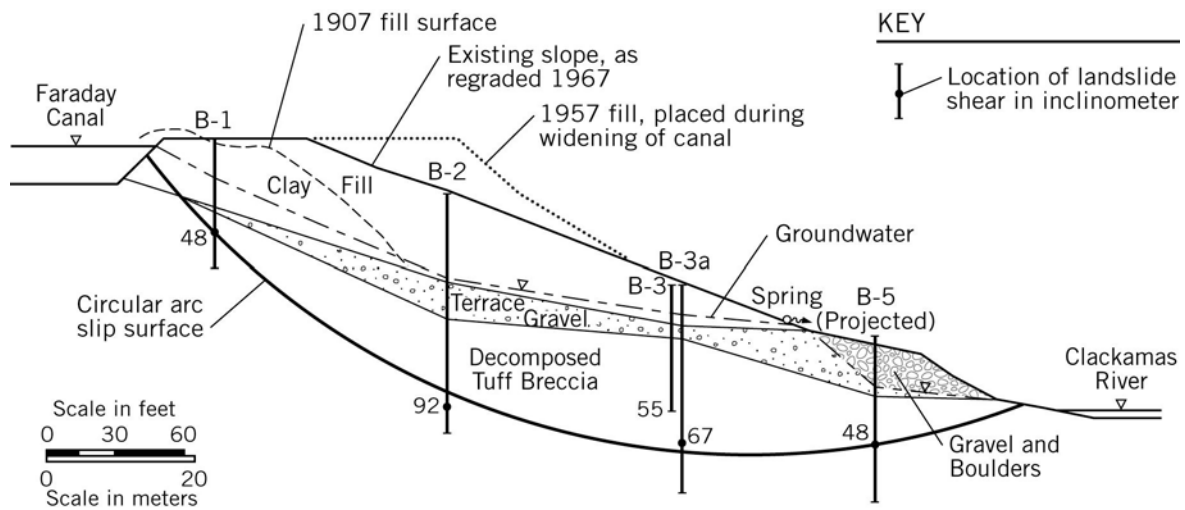

Figure 14. Faraday Canal landslide. Geological section through center of slide

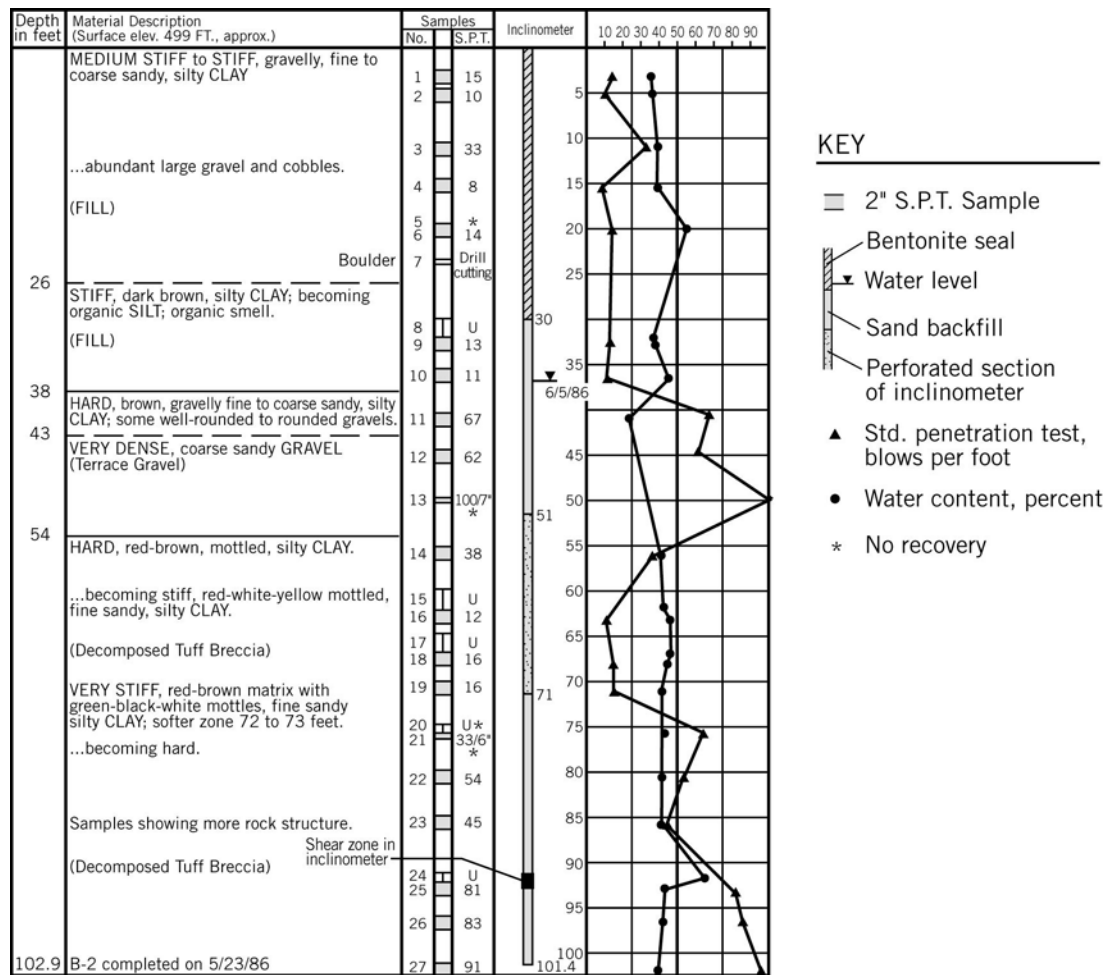

Figure 15. Faraday Canal landslide. Boring log for B-2.

The Faraday Canal diverts water from the Clackamas River to a hydroelectric generating plant. The original project was constructed in 1907. In 1957, the canal was widened and deepened to provide more power. Excavated soils were placed as fill on the slope between the canal and river. After cracks were observed on the slope in 1967, the slope was flattened to the current configuration. However, in 1977, new cracks appeared and landslide movements began to be monitored by surface survey hubs. The rates of movement steadily accelerated, and the landslide was stabilized by a rockfill buttress in 1989 (Figure 13). For additional details, see Cornforth, 2005, Case History 8.

The site investigation of 1986 included four borings through the center of the landslide to provide a geological section for stability analysis (Figure 14). The section shows a thick layer of clay fill overlying dense terrace gravel (old river channel) and hard silty clay (decomposed tuff breccia). A typical boring log from the site investigation is reproduced on Figure 15. There are exposures of the tuff breccia in the river bank close to the site where it stands at a near-vertical slope and has a rock-like appearance.

All the borings were instrumented with inclinometers. The observed movements (Figure 14) are a good example of a deep-seated circular arc slope failure. The slip surface passes almost entirely through the hard clay stratum below the fill and terrace gravel.

Without the benefit of inclinometer data, where would an experienced geotechnical practitioner expect the slip surface to be located? The probable choice would be at the base of the clay fill at the fill/dense gravel contact. This would be significantly in error. If using the boring logs as a guide, a second choice might be the “softer zone” at 72-73 feet (approx. 22 m) in Figure 15, for example. However, the actual depth of slippage at this location is 20 feet (6 m) deeper. Therefore, both choices would be wrong.

Sin No. 3. Incorrectly Interpreting Inclinometer Data

Although inclinometers play a vital role in determining the position of the slip surface in larger landslides, the plotted data of deflection versus depth can sometimes cause confusion to inexperienced users because they have unrealistic expectations of reliability. The probe itself takes very precise readings, but the overall reliability of the measurements is collectively controlled by the inclinometer *system* (i.e. the probe, casing, cable, quality of backfill, and skill of the operator).

The output graph usually shows the lateral movement of the ground relative to an initial set of readings. Two of the more common problems in interpreting inclinometer data are: (i) to leave systematic errors uncorrected, and (ii) to plot the data using highly exaggerated scales of lateral movement.

Systematic errors in inclinometer readings usually can be separated from actual displacement by mathematical techniques. Mikkelsen (2003) provides an excellent summary of these corrections. They include: (i) bias shift error, (ii) rotation error, and (iii) depth positioning error. Manuals and software are available from manufacturers to make these corrections. For difficult issues, specialist instrumentation consultants can be hired.

Bias shift is the more common error, and it is useful for all geotechnical practitioners to be able to recognize it and make the correction. This error is caused by the probe itself and, in multiple data sets, gives rise to the “windshield wiper” appearance on the plots. An example is shown on Figure 16(a). When bias shift error occurs, the stable portion of the casing below any actual movement shows an approximately linear plot, radiating from the bottom of the casing.

KEY

Initial reading: 1/15/91

- ▽ 1/22/91
- ◇ 3/18/91
- 4/29/94
- △ 6/10/96
- 5/11/99
- × 4/2/02

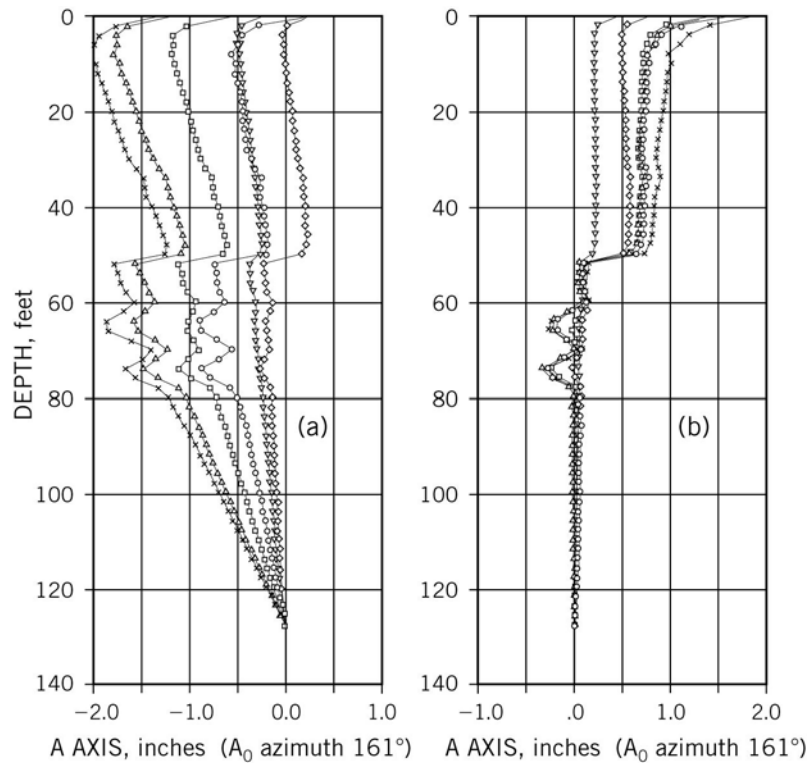

Figure 16. “Windshield wiper” effect for inclinometer readings, Percy Slide, Oregon:
(a) date uncorrected (b) data corrected for bias shift error

When corrected, as shown on Figure 16(b), the data shows that the actual landslide shear movement is occurring from 50 to 52 feet (15.2 to 15.9 m) below the surface.

The sloping lines of bias shift error should never be mistaken as representing actual movement and it is an easy correction to make, if needed. Whenever feasible, it is advisable to extend inclinometer casings 10 to 20 feet (3 to 6 m) below the likely depth of slippage. This makes it simpler to correct for bias shift error when analyzing the data.

The second error that some practitioners make when interpreting inclinometer data is to plot the graph to an exaggerated horizontal scale. This usually results from the desire on the part of the investigator to find out where the slip surface is located at the earliest opportunity.

An example of an exaggerated scale is shown on Figure 17(a). Such graphs can cause bizarre speculations of what is occurring within the landslide. In reality, the various wiggles in the graph are due to limitations of the inclinometer *system*, as mentioned earlier. When corrected for bias shift error and plotted to a more normal scale, as shown for this example on Figure 17(b), there is no movement occurring. Later, small movements occurred at this landslide site between 15 and 21 feet (4.6 and 6.4 m) below the ground surface (Figure 17c).

The author recommends that at least 0.15 inch (4 mm) of simple shear displacement should be observed at the discrete shear zone to confirm the depth of slippage. Also, displacements above the shear zone should be downslope of those below the shear zone.

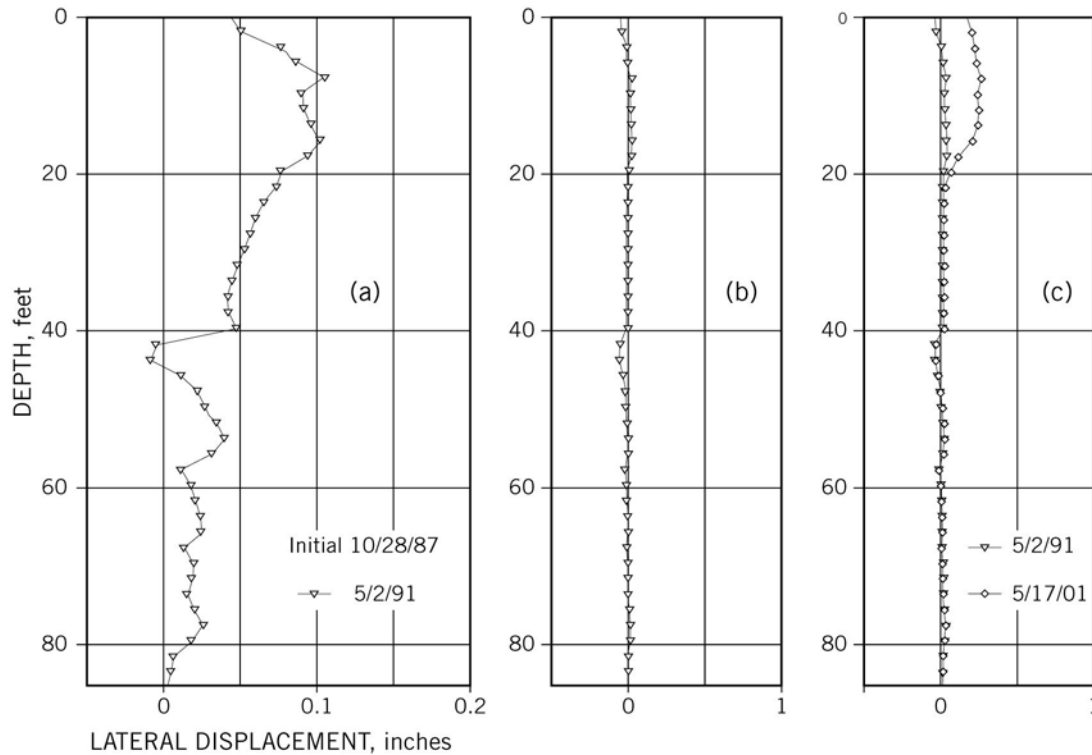

Figure 17. Effect of using highly exaggerated scales:

(a) horizontal scale 1 inch = 0.1 inch

(b) same data to a scale of 1 inch = 1 inch with bias shift error corrected

(c) later data showing actual shear movement at 15 to 21 feet (including correction for bias shift error)

Note: All scales reduced to 80% of original

Sin No. 4. Using an Inappropriate Factor of Safety

From the earliest days of soil mechanics, a factor of safety (F) of 1.50 has been the accepted norm for *slope stability* studies. This is appropriate, especially since most slope stability studies are performed for the design of relatively small earthworks, such as highway embankments, or for high risk projects, such as water-retaining dam embankments where there is a high risk of wide-scale property damage or fatalities resulting from a slope failure.

Unfortunately, the mindset of $F=1.50$ is sometimes treated as the norm for *landslides*. It can lead to designs that clearly exceed the need. Although such designs are conservative and ensure success, they are not in the broad interest of society if they are inappropriate for the type of landslide being studied. There is also the likelihood that no action will be taken to remediate the landslide because of the high cost or technical difficulties of providing an excessive level of remediation. In this case, a high factor of safety is being counter-productive. In recent years, some regulators have set a standard of $F=1.30$. However, a set limit, whether it is $F=1.50$ or $F=1.30$, is inappropriate as a standard for landslide work.

In contrast to most slope stability studies, where a fixed factor of safety can be accepted as standard, landslides:

- cover a very wide range of volume
- are performed at different levels of technical study

- are highly variable in their geological site conditions
- have a known factor of safety ($F=1.00$) at the onset of instability

The last of these differences is especially important because it provides one parameter of certainty in the mathematical analysis i.e. that the resisting force (or moment) is exactly equal to the driving force (or moment) at the onset of instability. Such information obviously does not apply to a stability analysis of a non-failure situation. Since a remediation analysis is a “before” and “after” study of the same landslide model, the geotechnical practitioner can, with some confidence, reduce the selected factor of safety in a landslide analysis compared to that of a conventional slope stability analysis.

A general guideline for landslide remediation is that the treatment should be sufficient to provide permanent stability against existing and reasonably foreseeable future site conditions. In the author’s opinion, the selected factor of safety should be set according to the professional judgment of the geotechnical practitioner, taking account of the factors listed in the matrix of Table 1 below.

Table 1. Factors influencing the selection of an appropriate factor of safety F

Variable	Factor of Safety should be relatively		
	Higher	↔	Lower
Type of landslide movement	Very fast	↔	Very slow
Level of study performed	Minimal	↔	Sophisticated
Size of the landslide	Small	↔	Large
Potential consequences to life and property of continuing movements	Significant	↔	Insignificant
Experience of geotechnical practitioner	Limited	↔	Very experienced

Assuming that the site has been adequately explored for geology and subsurface conditions (including laboratory tests of soil properties), the landslide has been modeled using piezometers and inclinometers, and that back analysis has been used to assign appropriate soil properties to the slip surfaces, it is the author’s opinion that design factors of safety can range from about 1.15 to 1.50. Factors of safety below 1.15 may be used in particular circumstances where a marginal improvement in stability is preferable to inaction.

Sin No. 5. Allowing a Contractor to Remove Support to a Landslide for Extended Periods during Remedial Construction

In performing the tasks of analyzing a landslide and the options for correcting it, a geotechnical practitioner may forget to consider the temporary excavation that a contractor must do as part of the remediating construction work. Contract specifications usually transfer responsibility for temporary works and site safety from the owner (and their agents) to the contractor. However, the reality is that, should things go awry, it is likely that the design geotechnical engineer will be named as a defendant in a lawsuit or as the responsible party for a site-related problem in a construction claim. Therefore, it is advisable for the design engineer to think through the construction process and try to avoid these types of claim.

Some common causes of landslide reactivation during remedial work are:

- oversteepening the landslide lower face to create space for a buttress or wall
- excavating soft ground below a landslide to provide a firm, level base for a buttress or wall foundation
- excavating a trench (“slot”) across a landslide for a shear key or interceptor drain

The common feature of these causes is that temporary excavations into the middle or lower reaches of a landslide almost always reduce slope stability and may reactivate movements. Since many landslide treatments require temporary excavations, the geotechnical design engineer generally needs to take an active role to prevent further movements.

The means to combat the loss of stability include: (i) performing remedial work at the time of year when groundwater is seasonally low i.e. during the late summer and fall in North America (ii) using sophisticated dewatering methods (not just sump pumping) before and during construction to temporarily lower groundwater levels (iii) using strutted support for trenches, if appropriate for the site (iv) designing walls with “top-down” construction methods that support the landslide at all times (Examples: tied-back soldier pile walls; concrete slurry trench walls; anchor block walls; soil anchors) (v) using closely-sequenced construction methods in which excavation is followed quickly by backfilling so that the time that the excavated face is kept open is limited to a practicable minimum (see below).

Another precaution at some construction sites is to monitor adjacent “sensitive” structures or pipelines before, during, and after construction. This may require structural surveys, photography, and inclinometer/piezometer installations. Such techniques provide factual information that can be used to separate claims for actual damages from claims based on perception or fraud.

Example E: Kalama landslide, Washington

A relatively minor excavation at the base of a hillside caused cracks to develop in the slope between the excavation and the road above (Figure 18). Borings put down alongside the road showed that hard bedrock (breccia) was 12 to 15 feet (4 to 5 m) below the existing ditch. A geotechnical consultant recommended that a 450-foot (137 m) long interceptor drain be constructed along the ditchline to intercept groundwater before it reached the unstable area below. The overburden soil was hard silt mixed with rock fragments (colluvium).

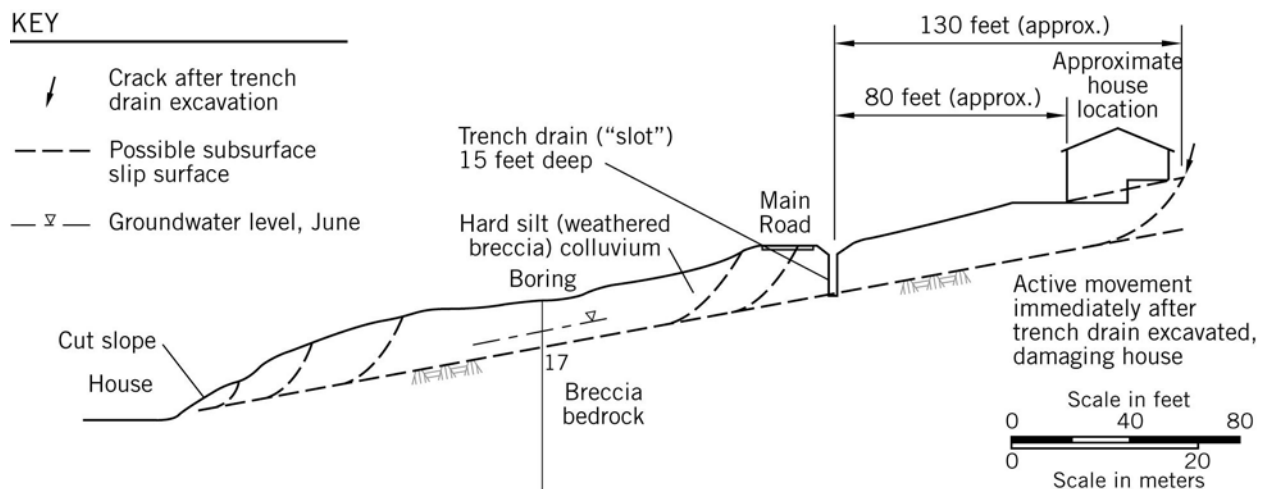

Figure 18. Kalama landslide: trench drain excavation causing movements in the upper slope.

In late spring, the contractor started trenching across the ancient landslide (colluvium) using a trench box to protect the workers from cave-ins. Almost immediately, there were reports that the uphill wall of the open trench was periodically collapsing. A house (Figure 18) uphill from the trench experienced severe cracking. This house was 130 feet (40 m) away from the trench, and there was anecdotal evidence that cracks were seen several hundred feet further upslope.

In this example, the consultant did not recognize the ancient landslide condition (see Sin No. 1 earlier) at the site, and the specifications did not require that closely-sequenced construction procedures would be needed to support the hillside during the trench construction. Instead, the contractor simply dug the trench leaving substantial lengths of it open for many days. This “slot” reactivated the ancient landslide terrain above it, and thus duplicated the cause of the original failure in the slope below.

The interceptor drain was finally installed using closely-sequenced construction procedures (see below). However, there was a substantial claim for damages from the affected homeowner due to the error of allowing an open trench to be cut across a pre-existing landslide.

Example F: Lorane Road landslide, Oregon

A highway improvement project near Lorane, Oregon, required a cut of 47 feet (14 m) horizontally into the hillside (Figure 19a), which was within ancient landslide terrain. Although the cut was made during the drier summer months, numerous vertical cracks developed over a distance of 90 feet (27 m) behind the top of the cut slope.

To prevent further regression towards a building upslope, a replacement buttress was designed. To build a replacement buttress, the weak soils at the outer face of the landslide are replaced by a stronger fill; in this example, shot rockfill was selected for the repair (Figure 19b).

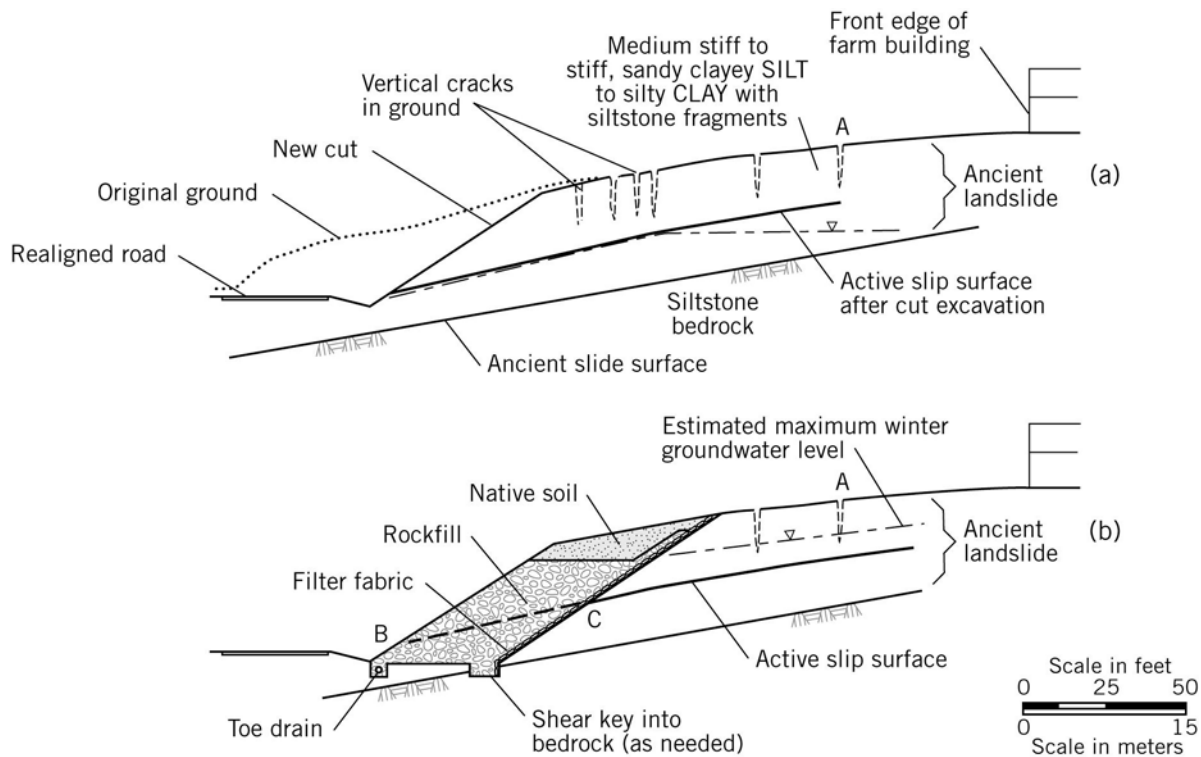

Figure 19. Lorane Road landslide: (a) landslide section (b) remedial section

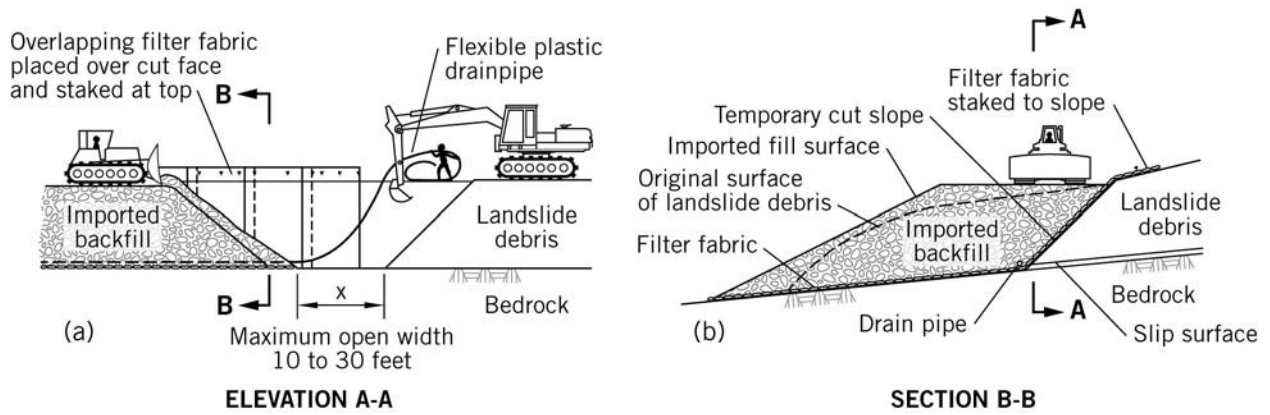

Figure 20. The closely-sequenced construction method

To build the lower section of the rockfill buttress, closely-sequenced construction was specified as mandatory.

The closely-sequenced construction technique is illustrated on Figure 20 and requires that excavation and backfilling occur together such that the length of open excavation is kept to a practical minimum at all times. When site work is suspended overnight or at weekends and holidays, the excavation is temporarily backfilled with loose excavated soils. These soils are quickly re-excavated at the start of the next shift. The need to totally backfill the open excavation overnight is discretionary, depending on site conditions, public safety, etc. On many sites, backfilling to zero base width (i.e. distance $x=0$ on Figure 20) is sufficient.



Figure 21. Closely-sequenced construction method being applied at Lorane Road landslide. On right, a backhoe excavates soil and loads spoil into a dump truck. On left, rockfill is being dumped and spread to build a buttress. Filter fabric (dark gray) is laid on the cut slope behind the rockfill.

Two stages of excavation were needed at the Lorane Road site. The first stage was to excavate the upper part of the slope, above the water table, by customary open excavation methods. For the second stage, a closely-sequenced construction procedure was followed, restricting the maximum width between the bases of the excavated soils and the rockfill (distance x , Figure 20) to 20 feet (6 m). A photograph of the work at Lorane Road is shown on Figure 21.

At this site, the pre-existing landslide condition was not recognized prior to construction of the cut. Excavating into the slope removed support from the marginally stable slope, thereby reactivating the ancient landslide. This example demonstrates the use of closely-sequenced construction to provide support when a “slot” or downhill removal of support is cut into a landslide condition.

Sin No. 6. Disregarding Artesian Pressures in Design

There is occasionally a “disconnect” between the group responsible for site investigations and their colleagues involved with design and specifications. One issue that has occurred twice in the author’s landslide experiences (and also in other foundation projects) has been disregard for flowing artesian conditions. It is included in the Seven Deadly Sins because, in each landslide case, the result of the oversight was extremely disruptive and costly for the affected parties.

Artesian groundwater is a well-known phenomenon to geologists and geotechnical engineers. To briefly recap, artesian conditions can develop where a water-bearing permeable stratum is overlain by a less permeable stratum (Figure 22). If the groundwater level in the permeable stratum (as measured by a standpipe or pressure gage) is above the ground surface, it is known as a *flowing* artesian groundwater. It can occur in slopes, especially those composed of colluvium, or it can be created by making a cut into a slope.

The hydraulic gradient between the artesian layer and the ground surface is h / L (Figure 22). If a cut is made into the impermeable upper stratum, the distance L decreases and the hydraulic

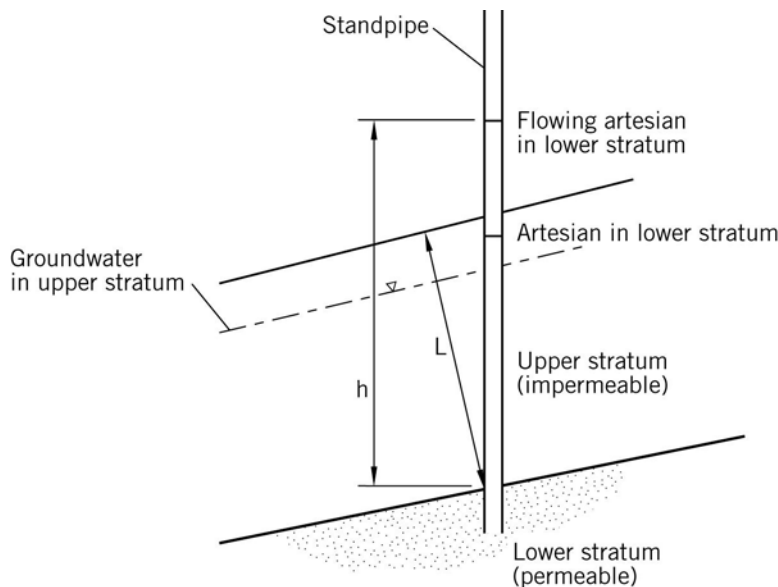

Figure 22. Artesian groundwater conditions

gradient increases. Should the hydraulic gradient rise sufficiently high, the flowing artesian pressure can erupt through the confining layer and cause a flow slide to occur. Therefore, if a flowing artesian pressure is encountered during a site investigation of a slope or landslide, it should be seen as a warning that excavations into the surficial impermeable stratum could cause instability.

Example G: Bonners Ferry landslide, Idaho

U.S. Highway 95 formerly passed around a ravine incised into glacial sediments near Bonners Ferry, Idaho. A road improvement project to shorten and straighten the highway required the construction of a 95-foot (29 m) high embankment crossing the ravine. The ravine bottom was partly covered with old landslide debris – a mixture of soft silt, sandy silt, and clay.

The site plan, Figure 23, shows the footprint of the proposed embankment. The contract required about 50,000 cu. yd. (38,000 cu. m) of the loose landslide materials to be excavated to provide a firm foundation for the embankment fill. This area is shown cross-hatched within the footprint.

The site investigation for the project encountered a flowing artesian condition in boring A-3 on the north (uphill) side of the excavation area (Figure 23). The boring log, simplified from the original, is shown on Figure 24. The artesian head, at a depth of 31 feet (9.5m) in the boring, was 9.6 feet (2.9m) above the ground surface in January, 1997.

The contract specifications warned the contractor that the slide debris was saturated, and that excavation would be needed below the water table. As commonly occurs in such contracts, a special provisions clause stated: “Any dewatering necessary for the excavation operation shall be considered incidental to Slide Debris Removal.”

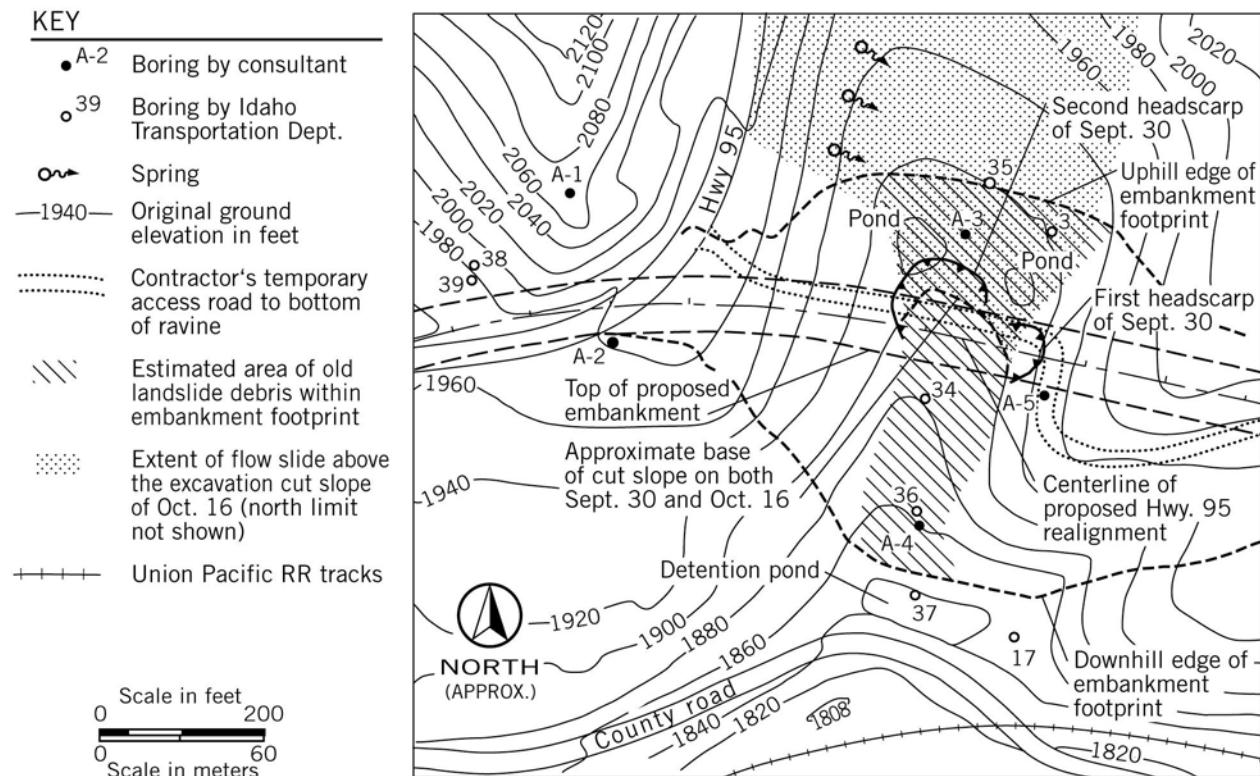

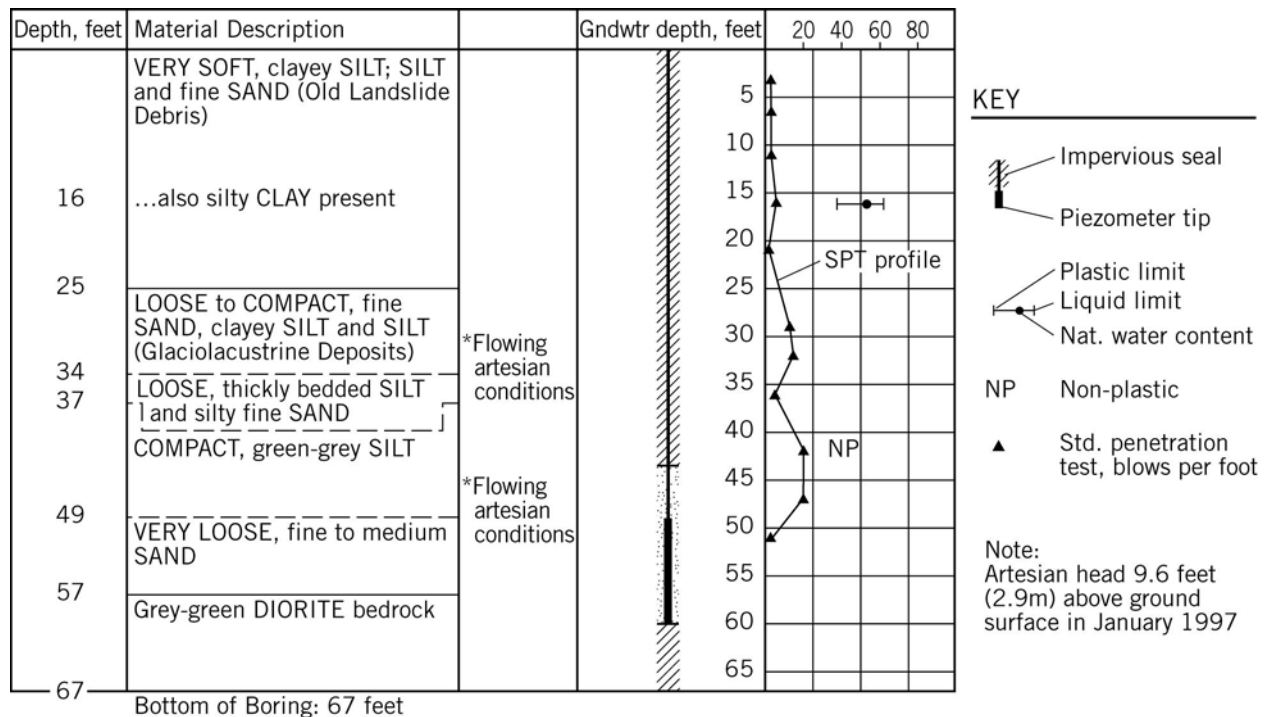

Figure 24. Bonners Ferry landslide. Summary log for boring A-3

In August, 1998, foundation excavation work began at the south (downhill) side of the embankment footprint and proceeded upslope. The track-mounted backhoe sat on the excavation floor, digging soil from the toe of the cut and loading it into trucks. After reaching the required excavation depth, rockfill was spread as a mat over the prepared foundation area. As this rockfill mat advanced into the excavation, the backhoe was able to sit on the edge of the rockfill as landslide debris was pushed off the slope towards it by a dozer. Seepage at the cut face caused the soft soils to slump, making it easier for the backhoe to pick up the soil.

On several occasions, fairly large collapses occurred due to the landslide debris liquefying and flowing down towards the excavator. On September 30, 1998, a flow slide of two “pulses” occurred. In the first flow, a dump truck was hit broadside and was pushed 100 feet (30 m) downslope. The second flow, 15 minutes later, pushed the dump truck all the way into the detention pond (see Figure 23). Three other mud waves followed, filling the 22-foot (7 m) deep detention pond and crossing the road below.

After these flow slides stopped, the construction crew built drains to pick up springs on the uphill side of the excavation. The height of the rockfill mat was raised from 5 to 8 feet (1.5 to 2.4 m) as a safety measure. After two weeks of cleanup and additional rockfill placement, the contractor renewed the excavation work at about the same place that had been reached before the flow slides.

On October 16, another small flow slide occurred at about 3 p.m., and this was followed by a major mudflow at 5:30 p.m. Numerous flow pulses continued from this time until about 3 p.m. of the next day (i.e. more than 20 hours). These flows built up behind the high railroad embankment downslope and then broke through the embankment onto the flood plain below (Figure 25). A video was taken of the flowing soils, estimated to be 10 feet (3 m) deep, coming down the ravine. When the movements stopped, the former cut face had regressed into a large headscarp that was 700 feet (210 m) further upslope. It eroded part of Highway 95, which was still in use. However, there were no fatalities or injuries.



Figure 25. Bonners Ferry landslide. Aftermath of the major flow slide, showing rupture through the railroad embankment and into the flood plain (in foreground). (Photo: David Kramer)

It is likely that the depth of cut left only a relatively thin layer of in-place sediments above the artesian stratum, causing a critical hydraulic gradient. The upwelling of artesian groundwater liquefied the soils to begin the flow slide. Once initiated, it progressed steadily upslope as ground was lost and flowed away, undermining the ground above to continue the flow.

There were severe economic losses. The main line of the railroad was closed for several days until the embankment could be rebuilt. Highway 95 was closed for 18 days, and required construction of an alignment shift into the hillside where it had been undermined by the flow slides. The road closure required a 112-mile (180 km) detour. Power to the town of Bonners Ferry was lost and schools were closed for several days. The construction contract was delayed, and there were lawsuits to recover damages.

Construction Dewatering for Temporary Works

It is a longstanding practice in civil engineering projects to make the contractor responsible for the construction and safety methods employed to build a project. At Bonners Ferry, a very experienced contractor was using a risky excavation method i.e., allowing the springs in the cut face to cause a local failure that moved loose, saturated soils towards the excavator. This technique cannot be easily controlled and several flows and slumps preceded the September 30 and October 16-17 mudflows. This method of excavation is common practice in construction.

The catastrophic mudflows could have been prevented by suitable dewatering of the site area prior to the excavation i.e. by deep wells or wellpoints. This would have allowed excavation to occur under drawdown groundwater conditions. As previously stated, the special provisions of the construction contract required the contractor to provide any dewatering as part of the bid price for excavation. However, dewatering covers a wide range of practices and cost, ranging from low-cost sump pumps to a sophisticated design of deep dewatering wells that are installed and made operative before any excavation takes place. Without specific instructions to use a sophisticated dewatering method, no contractor would include such costly and time-consuming measures in a bid price. To do so would ensure that their bid would be high in comparison to others who had made no such allowance.

The type of problem described in this case history is common whenever excavations pass below the groundwater table in sands and silts, and frequently cause delays, cost overruns and lawsuits. Furthermore, the foundation area is loosened in comparison to the pre-existing conditions at the site. This change is undesirable for the finished project, and may change the design assumptions with respect to soil strength and compressibility.

One procedure that can avoid these contractual problems is to treat construction dewatering at sites with artesian groundwater or groundwater above the depth of temporary excavation as a *design* issue rather than as a temporary measure under the control of the contractor. It can be specified that the contractor employ an experienced consultant to design a site dewatering system and verify that it is properly installed and working before excavation begins. This can be a separate price item in the bill of quantities to emphasize its importance to the project. The effect of such an approach is that instability due to high groundwater is avoided, the contract work proceeds smoothly, and the foundation integrity has not been compromised by ground softening.

Sin No. 7. Constructing Large Fills Over Soft Sediments Underlain by Steeply-Inclined Bedrock

Glaciers of the Pleistocene era left behind steeply-inclined hard rock surfaces which today provide fjords and deep lakes. At the shoreline, these slopes may have a narrow gravel beach above the hard rock that can support manmade structures, such as roads, railroads, or other commercial developments. However, the offshore environment may be very different and have deep deposits of soft silts and clays brought into the area by rivers and streams. These fine-grained sediments generally are normally consolidated and have a high sensitivity to remolding.

There have been many examples of slope failures where fills of significant mass have been put into the water above such weak soils. In projects known to the author, these failures have occurred rapidly. Some fatalities have occurred. In each case, site explorations were minimal prior to construction, probably due to the longer time and higher costs involved with over-water borings and probes. In most situations where soft, sensitive sediments overlie steeply-inclined bedrock, it is impractical to build fills above them.

Example H: Lake Pend Oreille landslide, Idaho

The northeast side of Lake Pend Oreille in Idaho has steep rock slopes and a narrow strip of flatter ground along the shoreline. In 1966, the U.S. Bureau of Public Roads decided to realign Highway 200 from Hope to Denton to eliminate hazardous curves. The start of this project required the road to cross the Northern Pacific Railroad and curve back to an alignment parallel to the railroad tracks (Figures 26, 27). The horizontal curve required a substantial fill to be placed into the lake near the overpass structure.



Figure 26. Lake Pend Oreille landslide. Hope Overpass site. Piers 2 and 3, on opposite sides of the Northern Pacific railroad tracks, are under construction in the background.

The embankment fill was a shot rock, primarily of gravel size. This was end-dumped and pushed into the lake. However, the fill simply “disappeared” into the lake as quickly as it was being placed. According to an eye-witness report, sliding was continuous and dump truck operators refused to drive their trucks near the fill edge. Work was suspended after an estimated 30,000 cu.yds.(9,100 cu.m) of fill had slid into the water.

The only site investigations in this area prior to the work suspension were on-land borings (1, 2, 3, 4, Figure 27) that encountered terrace gravels overlying bedrock. After the failure, seven over-water borings were put down (5 to 11, Figure 27). They encountered soft, silty clay underlain by argillite bedrock.

A hydrographic survey of the failure area (Figure 27) showed that a deep trough had been scoured out below the lake by the landslide. A cross-section taken through the center of the trough (Figure 28) showed a mound below water with the top at depths of 50 to 60 feet (15 to 18 m) below the lake surface. The steep outer slope of the mound (maximum 45 degrees to the horizontal), is interpreted to be angular rockfill that slid to this position. The clay that was formerly at this location apparently had been eroded and flowed into a deeper part of the lake. Unfortunately, none of the over-water borings were within the trough. However, the borings on both sides of it provide a means (by interpolation) to draw approximate contours of the ground surface, bedrock surface, and the depth of clay sediments. These contours (not reproduced here) show that the clay progressively thickens from 0 at the shoreline to 60 feet (18 m) in boring 10.

Boring B-6 is typical of the near shore conditions (Figure 29). This boring had gravelly soils near the ground surface, the gravels being either beach gravel and/or fill from the construction work (there was poor sample recovery in this stratum). For all borings, the lacustrine clay

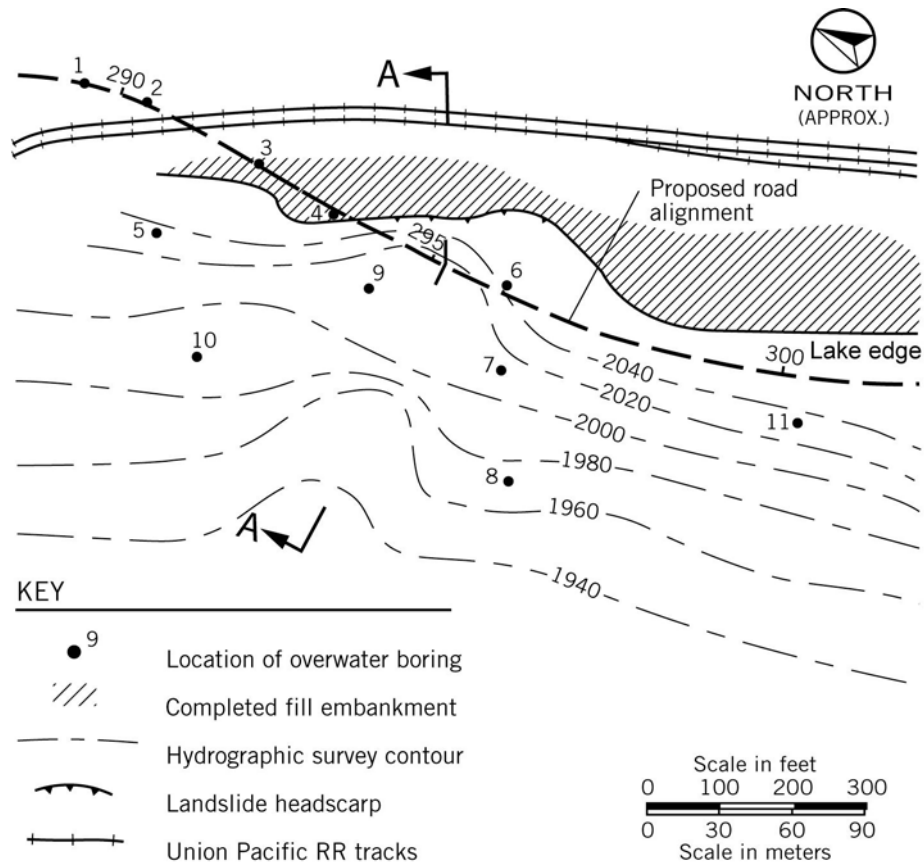

Figure 27. Lake Pend Oreille landslide: Site plan

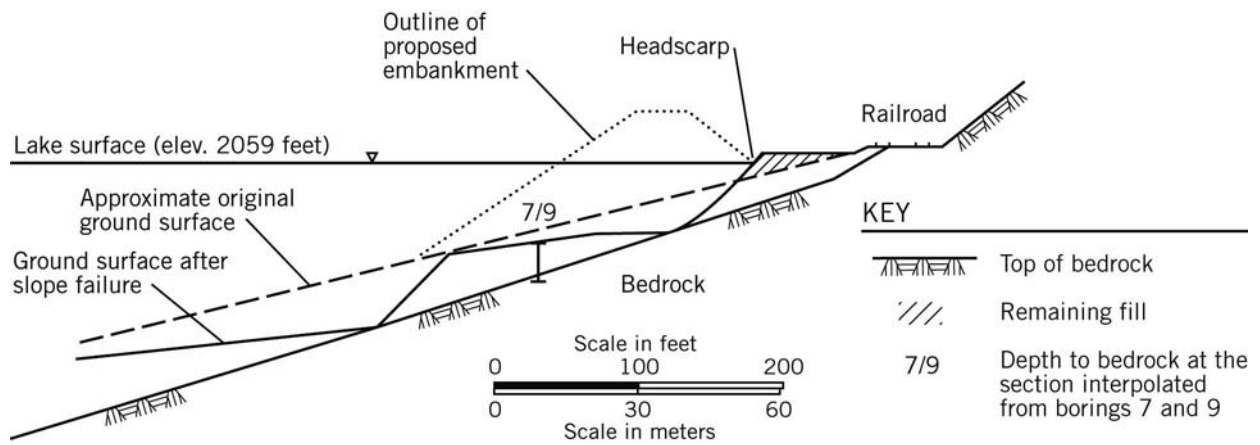

Figure 28. Lake Pend Oreille landslide: Section A-A

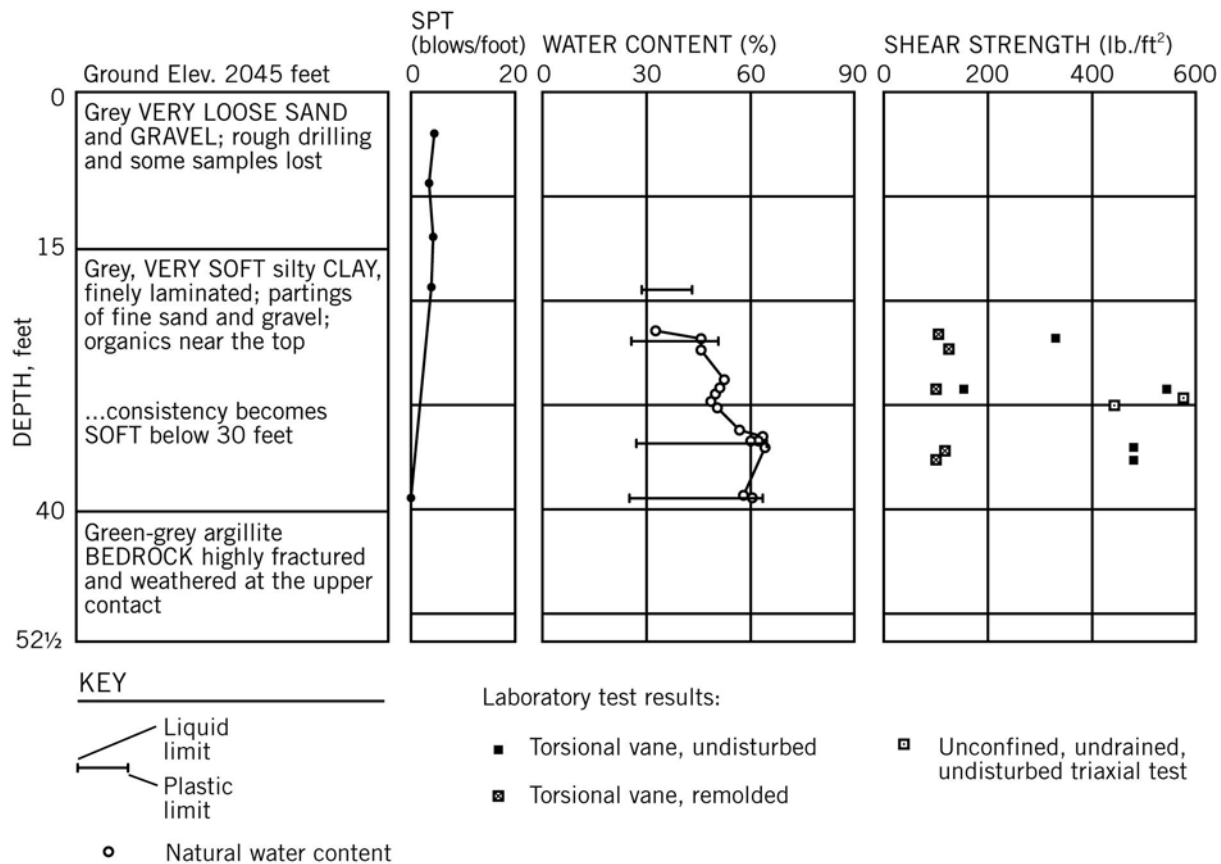

Figure 29. Boring log and clay properties in boring B-6

sediments were described as very soft clayey silt to silty clay containing thin layers and partings of sandy silt, fine sand, and occasionally gravel. Many samples had a laminated (varved) structure. The average index properties were: liquid limit 54; plastic limit 27; natural water content 68%. The shear strengths, based on torvane tests, increased approximately linearly from only 50 lbs./sq. ft. near the surface to 250 to 600 lbs./sq. ft. at a depth of 30 feet (metric: 2.4 kPa near surface to 12 to 29 kPa at 9m depth). The median value of sensitivity to remolding is 5. The measured effective stress parameters in consolidated-drained triaxial tests using very slow rates of strain were: $c' = 0$, $\phi' = 24$ degrees.

As can be seen from the above data, the Pend Oreille lake clays are very weak and normally consolidated. They were completely incapable of supporting the planned high embankment. At a site with these subsurface conditions, non-displacement piles driven or predrilled through the soft sediments to bearing in bedrock can be used to support a bridge or causeway.

Example I: Copper Ore Facility landslide, Skagway, Alaska

The east side of Skagway harbor has a very steep slope of hard rock that plunges into the fjord of Taiya Inlet (Figures 30, 31). Below water, a slope of soft marine silt has been deposited between the steep rock slope and the delta of the Skagway River.

In 1966, a contract was let to build a copper ore loading facility next to the south end of the existing Pacific and Arctic Railway and Navigation Company (PARN) dock. The project was to build a platform fill into the bay and construct a 60-foot x 160-foot (18 x 50 m) building on the fill.



Figure 30. Steep rock walls on the east side of Skagway harbor.

The “site investigation” consisted of driving seven wooden piles into the ground from a floating barge. Four of the seven piles sank 10 to 15 feet (3 to 4.5 m) under the weight of the pile-driving hammer, indicating very soft underwater conditions. An old timber wharf was demolished and fill was placed into the bay on 12-hour shifts. Four weeks later on October 29, 1966, when the work was nearly completed, most of the fill collapsed and disappeared below water overnight.

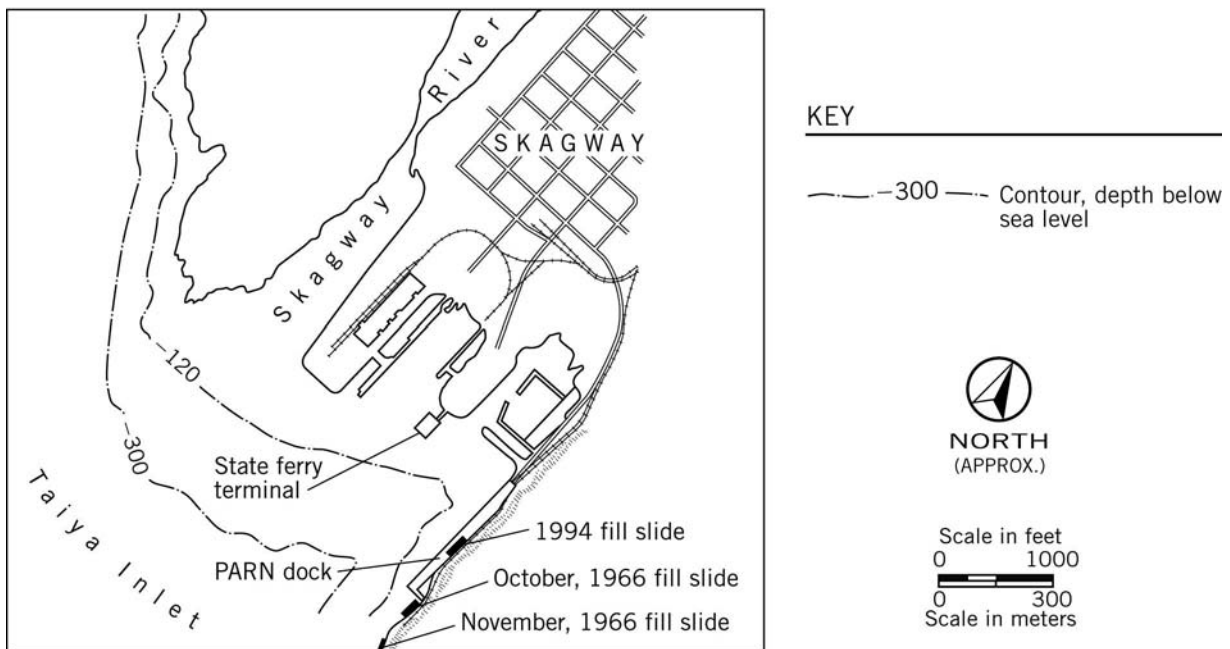

Figure 31. Skagway harbor and landslide sites

Subsequent investigations showed that the Skagway tide gauge, close to the site, recorded a wave occurring near the low tide of elevation -1 foot (-0.3 m) at about 7 p.m. on the night of the failure. A ferry terminal employee in Skagway lost telephone contact at about the same time. It is understood that the submarine telephone cable broke approximately 1.5 miles (2.4 km.) south of the slide. This suggests that a flow slide resulting from the fill failure traveled a considerable distance down the slope into Taiya Inlet. Bjerrum (1971) cites a similar occurrence in Norway. Seed (1983) reported that several failures of fill slopes in coastal areas occurred at extreme low tide. At such times, the stability is most critical because, at higher tide levels, the water outside the slope provides support.

The approximate plan of the fill (Figure 32) shows that the level top surface was about 230 feet (70 m) long parallel to the shoreline and extended 50 to 70 feet (15 to 21 m) into the bay. A “before” and “after” cross-section X-X near the center of the fill (Figure 33) shows the loss of ground. It is calculated that about 13,000 cu.yds. (10,000 cu.m) of fill was lost.

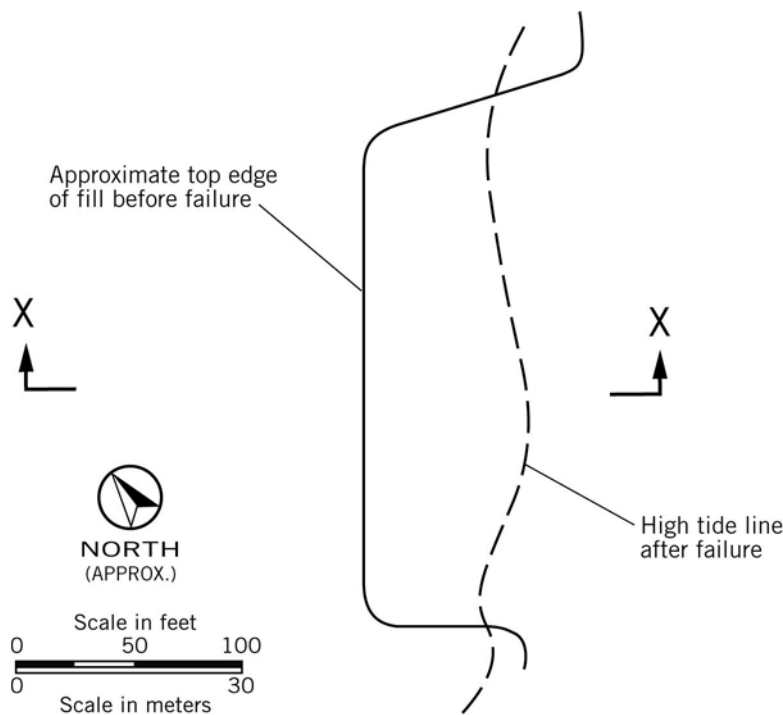

Figure 32. Skagway October 1966 flow slide: Site plan

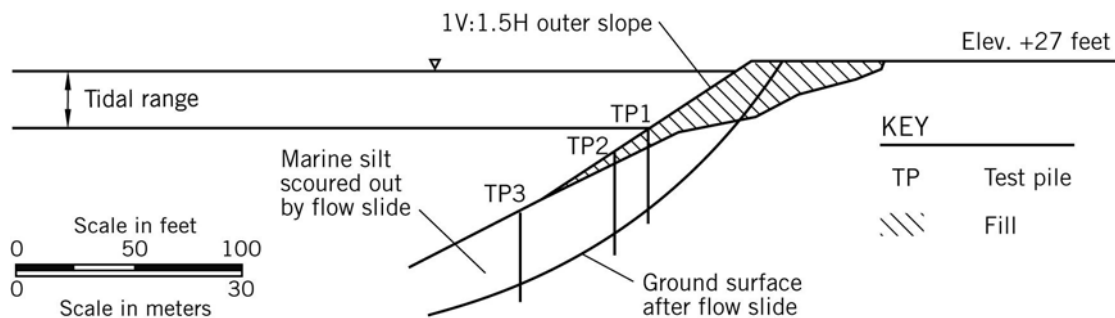

Figure 33. Skagway October 1966 flow slide: Section X-X

Following the October 29, 1966 landslide, the project developers tried to build another fill. On November 8, 1966 the original contract was amended to build a fill into the harbor 400 feet (120 m) further south (see Figure 31 harbor plan). The contractor began filling immediately, but the project was stopped on November 30 because a 300-foot (90 m) long crack with a 2-inch (50 mm) vertical displacement had appeared on the fill surface parallel to the shoreline. The site was abandoned.

Lest any reader should think that this type of event is confined to the “old” days of 1966, it should be mentioned that yet another fill was built into the harbor at Skagway in 1994 as part of the PARN dock improvement. In this case, a platform fill was built out from the shoreline and a very large heap of riprap was placed on it. This slope failed at extreme low tide on November 3, 1994 taking out the remains of the old wooden dock to the south and the partly-completed improvements. The wave, estimated to be 60-feet (18 m) high from peak to trough, pulled the floating ferry terminal out of its moorings on the other side of the harbor. The volume of fill, including riprap, at the time of failure was calculated to be 12,700 cu.yds.(9,700 cu.m). This is almost the same fill volume as the Copper Ore Facility landslide of 1966, which occurred only a short distance away on the same side of the harbor. The 1994 landslide requires more description than is possible here. It is described in some detail in Cornforth (2005).

The marine silt properties measured on samples taken at the two Skagway sites were almost identical. The soils ranged from non-plastic silt to clayey silt and were soft to medium stiff in consistency. As measured after the PARN dock failure, the average silt properties were: natural water content 31%; liquid limit 27%; plastic limit 22%; plasticity index 5. The average undrained shear strength was 1100 lbs./sq. ft. (53 kPa), based on in-situ vane tests at 17 feet (5m) below the mudline (after failure), and the sensitivity to remolding was 6. Effective stress parameters were a surprisingly high $c' = 0$, $\phi' = 38$ degrees.

Conclusions and Recommendations

Sin No. 1. At a site proposed for development, an essential first step is to determine whether or not there is a landslide on the property. Pre-existing landslides can range from fully stable to active. It usually takes only minor adverse changes in loading or support for such landslides to become more active. Therefore, any pre-existing landslide needs to be fully evaluated during design to maintain or improve stability.

Sin No. 2. The depth of slippage is needed to model a medium or larger size landslide in a stability analysis. Interpreting boring logs or shallow test pits to estimate the slippage depth is generally unreliable. It should be measured by field instrumentation designed for this purpose, such as inclinometers.

Sin No. 3. Unrealistic expectations of the accuracy of inclinometer systems can lead to erroneous interpretations of the collected data. Two common problems are: (i) to leave systematic errors uncorrected, and (ii) to plot the data to exaggerated scales in the hope of detecting movement at the earliest opportunity. The author suggests that at least 0.15 inch (4mm) of simple shear displacement should be observed at the discrete shear zone to confirm the position of the slip surface.

Sin No. 4. Using a factor of safety in remedial design that is too high is counter-productive. It provides a remedial treatment that exceeds the need, or it may be concluded that stabilization of the landslide is not feasible at an acceptable cost. Since landslide stabilization design is based on a comparison of “before” and “after” analysis of the modeled cross-section, and knowing that the factor of safety is exactly 1.00 at the onset of movement, an experienced practitioner can use

judgment to select a factor of safety between 1.15 and 1.50 that is appropriate for the project. Factors influencing this decision are listed on Table 1.

Sin No. 5. Be aware that temporary remedial work, especially trenches and lower slope excavations, may reactivate a landslide. It is recommended that the geotechnical practitioner mention (in technical reports) the need for temporary (short-term) slope support systems during remedial work. These may require retaining walls, sophisticated dewatering systems, closely-sequenced construction techniques, favorable time of year for construction, etc., depending on the site specifics.

Sin No. 6. Always pay special attention to artesian conditions encountered during a site investigation. Should a landslide remedial treatment require temporary excavations, there is a danger that a critical hydraulic gradient may develop between the artesian layer and the excavation face during construction, causing a flow slide. A proactive approach is to treat the possibility of instability as a *design* requirement rather than leaving it as temporary works at the discretion of the contractor. It usually requires the contractor to install a sophisticated dewatering system.

Sin No. 7. It is almost impossible to safely construct a substantial fill over soft sediments that are underlain by steeply-inclined bedrock. These conditions are encountered in fjords, where marine silts are being actively sedimented, and in glacially-formed lakes.

REFERENCES

- BJERRUM, L. 1971. Subaqueous slope failures in Norwegian fjords. *Norwegian Geotechnical Institute, Bulletin 88*, 8pp.
- CLARKE, D.D. 1904. A phenomenal landslide. *Transactions ASCE, Vol 53, Paper 984*, pp 321-411.
- CORNFORTH, D.H. 2005. *Landslides in practice* John Wiley & Sons, Inc., Hoboken, N.J. 596 pp.
- MIKKELSEN, P.E. 2003. Advances in inclinometer data analysis. *In: Symposium on Field Measurements in Geomechanics, Oslo, Norway.* (Editor: Frank Myrvoll) A.A. Balkema, Liss, Holland, pp 555-567.
- SEED, H.B. 1983. Stability of port fills and coastal deposits. *In: Proceedings of Seventh Asia Regional Conference on Soil Mechanics and Foundation Engineering, Technion Israel Institute of Technology, Haifa, Israel.* 24 pp.